



Educational Cards

Kids' Athletics



Educational Cards

Kids' Athletics

Edition 2006

A product of a Working Group composed of:

Charles Gozzoli (FRA)

Jamel Simohamed (ALG)

Abdel Malek El-Hebil (MAR)



Practical guidelines: Training to Kids' Athletics events

Educational cards for 7-12 year-old children (Kids' Athletics)

For each Kids' Athletics' event, 5 educational cards are presented recommending 5 training situations.

These cards do not follow a teaching progression. They merely present 5 possible training situations for the young participants. It is the educators' responsibility to select and to organise the sessions taking account of the children's needs.

Some events are not developed over 5 educational cards, for the following three reasons:

- In open events, educators have to show a minimum ability to come up with new ideas in terms of training:

(Ex.: To prepare the target throw event, any throw at a target is considered as a training exercise (ball sports, game of skill, etc).

- In some events which are close to the events intended for adults, we do not wish to submit children, within the frame of Kids' Athletics, to any specific training for the events. The various training situations in preparation for an event are enough to ensure they can face up to new events successfully.

(Ex.: 1000m Endurance Event is prepared by the 8' Endurance and Progressive Endurance).

- If the event is a progressive form of another event, it does not offer other training situations than those preparing for the event.

(Ex.: Triple Jump within a limited area is prepared by the short run-up Triple Jumping Event).

WARNING

Some educational cards do not correspond to IAAF Kids' Athletics Events (Race Walking, High Jump) for the following reasons:

- *the safety of the participants (High jump: landing without mats)*
- *the technical complexity (race walking, fosbury-flop)*

However, it is highly recommended to present these jumping/walking practices through preparatory exercises, as they will be discovered at a later stage.

EDUCATIONAL CARD : SPRINT/HURDLES SHUTTLE RELAY

Analysis of the event: The event requires mastering low obstacles clearance at running speed and the ability at organising one's strides over a given distance.

Safety of the participants: The selection of the area for practice is important (soft, non-slippery, flat). The hurdles selection is also crucial for safety (safe: light, solid, etc.). The courses should be adjusted to the various levels of the participants.

Figure

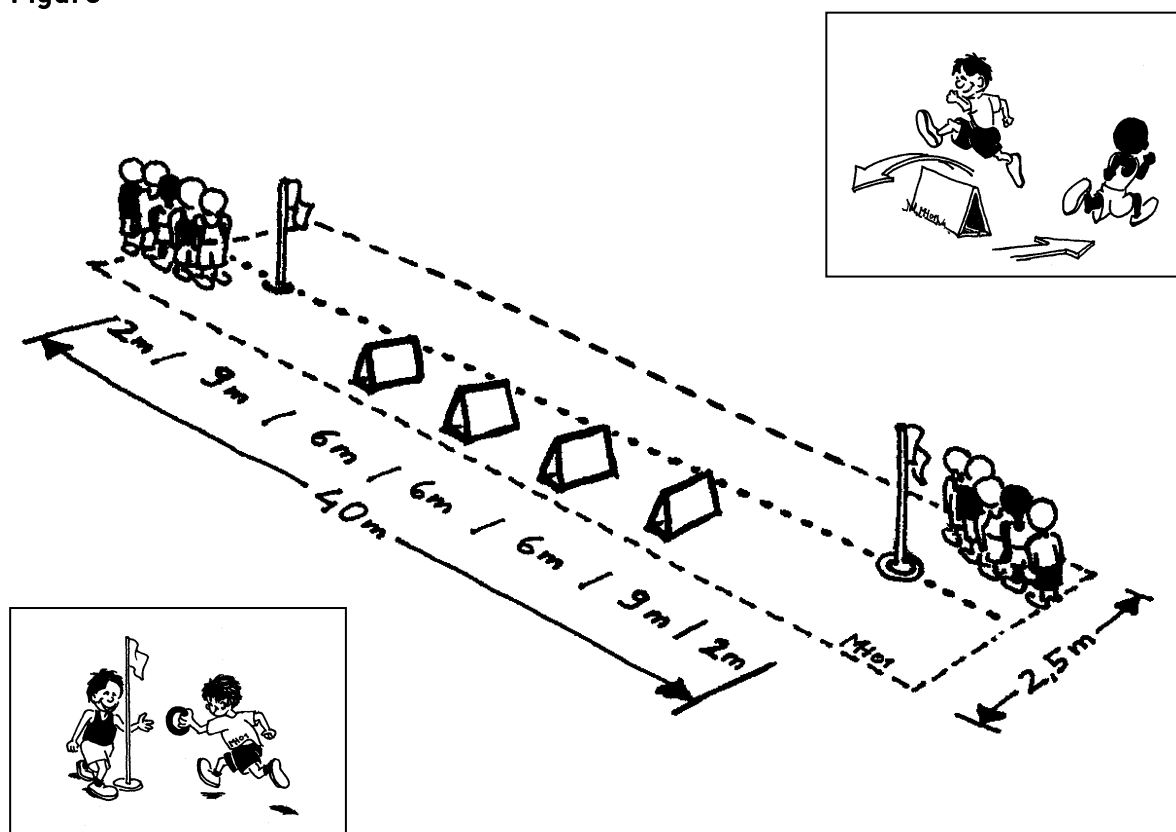

Event from IAAF Kids' Athletics Competition

Educational Card 1: Sprint/Hurdles Shuttle Relay

Objective: To improve the obstacle clearance

Proposed situation: Organise a course with various implements for jumping practice (vertical – horizontal clearance) which are distributed at random.

The beginner's behaviour: Beginners are hesitant before the obstacles, and often land in the safety position (two feet touchdown).



Instructions for the exercise:

- Run as regularly as possible
- Make a fast transition to running after clearance

Noticeable points:

- Keep balance after clearance
- Master the obstacle clearance with a roughly horizontal position
- Do not slow down before obstacles
- Use the free segments for drive and not for balance

Teaching progression:

- Vary the obstacles (high, low, long, various)
- Vary the distances between hurdles
- Vary the sequences of exercises
- Move towards individual or collective games

Safety:

- Safe courses
- Appropriate obstacles

Equipment:

- Horizontal markers
- Vertical markers for the course

Educational Card 2: Sprint/Hurdles Shuttle Relay

Objective: To improve the organisation of the distance between the starting line and the 1st obstacle

Proposed situation: Have 3 different courses (5, 6, 7m) at the participants' disposal as following:

Start from a crossbar on the ground

Safe obstacles are placed at a 5-m, 6-m, 7-m distance (they are low so that can be cleared easily).

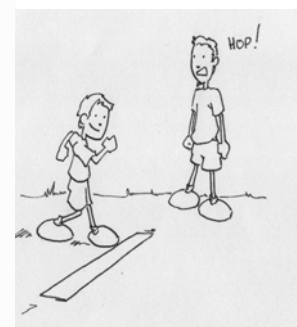
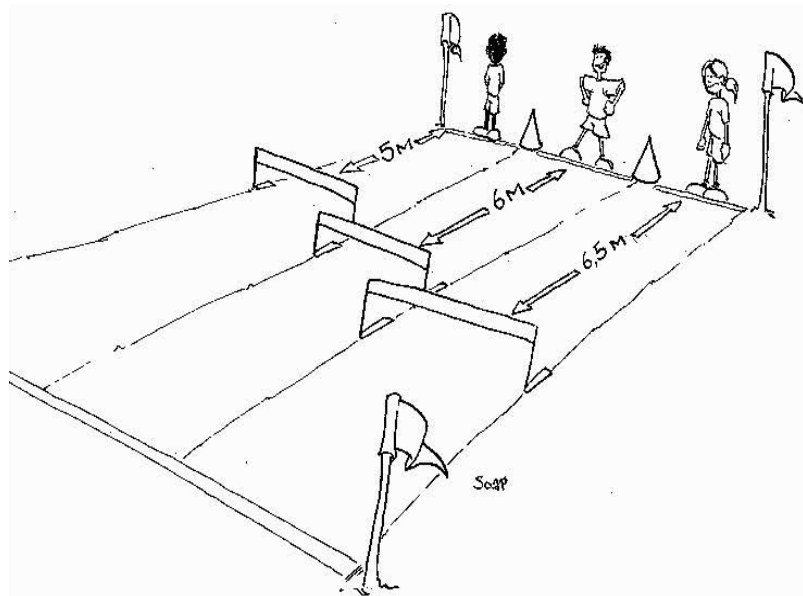

Starting position

Instructions for the exercise:

- Do not slow down before the obstacles
- Sprint until the finishing line
- Make a fast transition to running after clearance

Noticeable points:

- Progressive acceleration towards the obstacle
- Progressive stride amplitude
- Take-off is taken far from the hurdle
- Active and balance landing after clearance

Teaching progression:

- Vary the distances
- Run in pairs
- Keep the time
- Move towards play activities

Safety:

- Safe courses
- Appropriate hurdles height and in-between spaces
- Organisation of the group

Equipment:

- Hurdles
- Vertical markers on the course

Educational Card 3: Sprint/Hurdles Shuttle Relay

Objective: To improve the running strides over the distances between hurdles

Proposed situation: Carry out in-between distances, to be gradually increased and ask the participants to work on the stride amplitude and the number of strides (compulsory or free).

The beginner's behaviour: Beginners will work on the number of strides keeping their own regular pace; they land in the safety position (two feet touchdown).

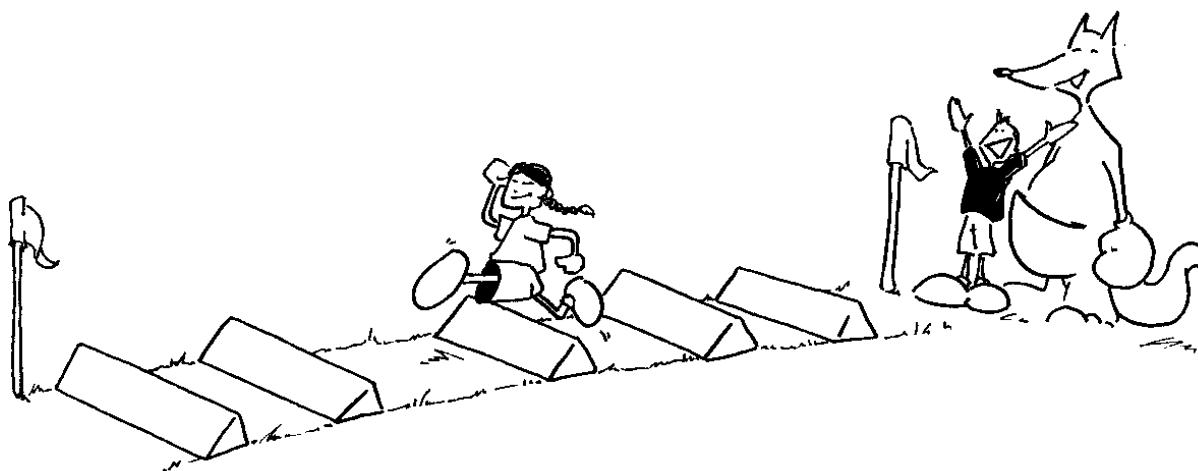

Instructions for the exercise:

- Work on different stride amplitudes
- Remain at running speed

Noticeable points:

- Maintain a regular pace
- Saving strategy of running
- Balance and correct general position are maintained

Teaching progression:

- Vary the distances
- Vary the requirements (contracts)
- Keep the time
- Move towards individual games or collective games

Safety:

- Non-slippery ground
- Safe obstacles
- Organisation of the group

Equipment:

- Hurdles
- Vertical markers

Educational Card 4: Sprint/Hurdles Shuttle Relay

Objective: To improve the baton handling

Proposed situation: Catch and release a baton (tennis ball, soft ring, relay baton, etc.) placed at hip level at running speed.

The beginner's behaviour: Beginners have great difficulty separating their arm action from their running action. Their arm accompanies the sprinting movement and can not carry out an accurate action.

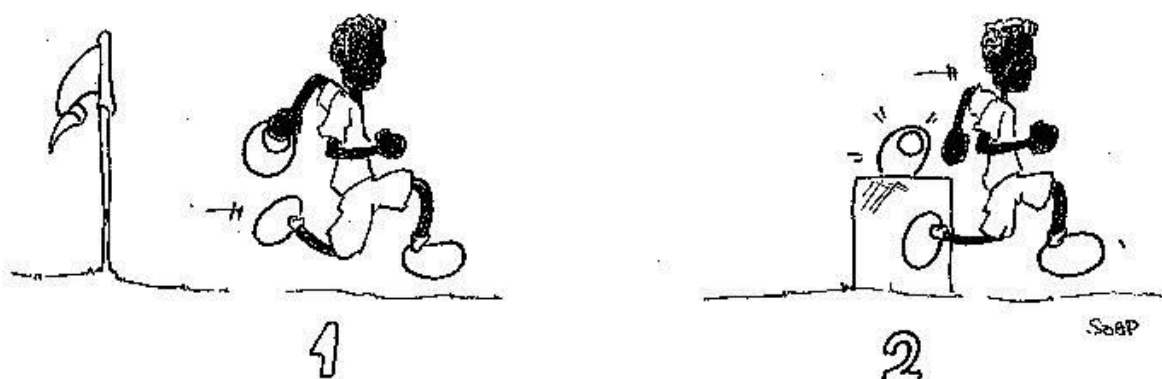

Instructions for the exercise:

- Remain in a relaxed position
- Do not turn the head towards the target

Noticeable points:

- Catching/Releasing the implements with precision and regularity
- No disruption in the sprinting movement (from the carrying arm only)
- No loss of speed during the exercise

Teaching progression:

- Vary the implements and the speed
- Use the right hand, the left hand
- Complete sequences : release/catch, catch/release
- Perform the exercise with changing hands
- Move towards games

Safety:

- Course without obstacles
- Organise the group
- Baton placed at the appropriate height

Equipment:

- Batons or various implements
- Support for relay batons

Educational Card 5: Sprint/Hurdles Shuttle Relay

Objective: To improve on the changeover and react to sound or a visual starting signal

Proposed situation: After a given signal two participants take a simultaneous start, 10 m apart, facing each other. They will pass each other at running speed, and will complete the exchange without slowing down.

The beginner's behaviour: Beginners will struggle on deciding which hand will receive the baton. They are often placed in front of the incoming runner. They remain very clumsy during the changeover.

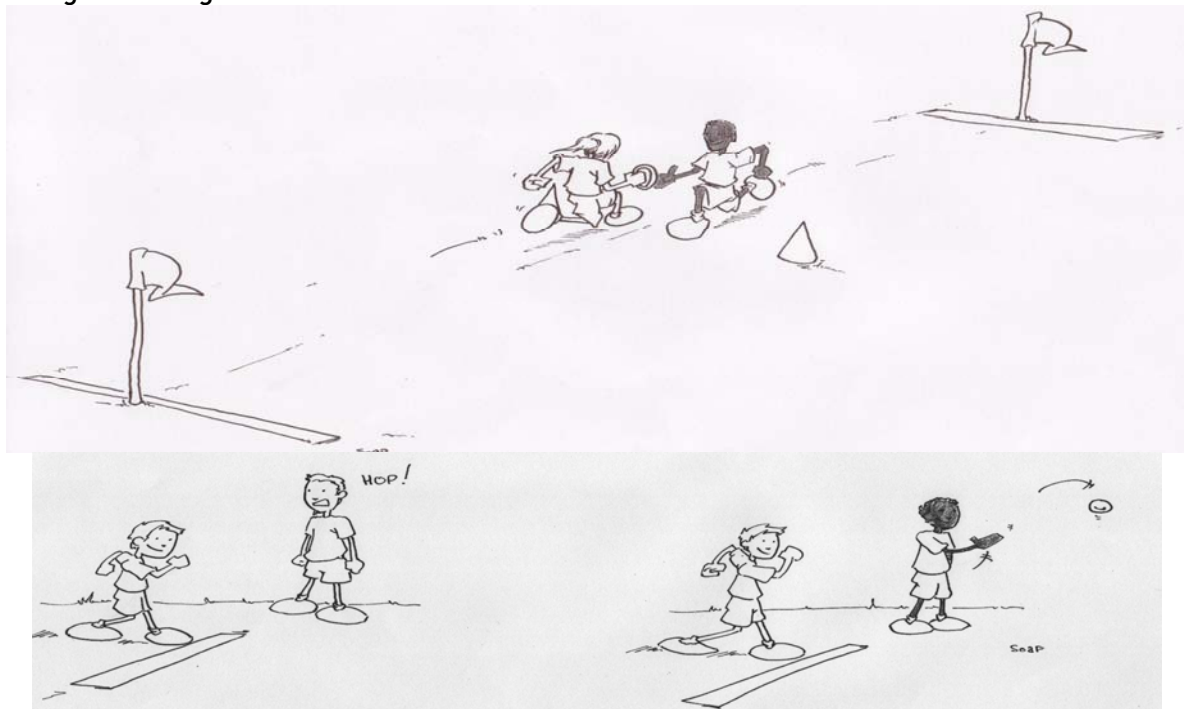

Instructions for the exercise:

- Run in shifted trajectories, on the baton-relay side
- Correct action of the arm to catch the baton

Noticeable points:

- Do not drop the relay-baton
- Both participants do not slow down
- Changeovers are successful on a regular basis

Teaching progression:

- Change hands on both sides
- Increase the speed
- Vary the forms of baton
- Keep the time (starting/finishing lines are the same)
- Move towards games

Safety:

- Organisation of the group
- Safe relay-batons
- Clearly marked trajectories

Equipment:

- Vertical markers
- Relay-batons

EDUCATIONAL CARD: 8 MIN. ENDURANCE

Analysis of the situation: This event demands the obedience of the running speed within strict speed requirements. This is an individual event in a team background. Each participant keeps to a speed table to help his/her team.

Instructions for the safety of the participant: The preparation for the event is certainly the best guarantee of safety. Markers along the distance, as well as reference points for the team base must be safe. Educators on each base will have to give advice to every child after every turn.

The situation of the event: Kids' Athletics

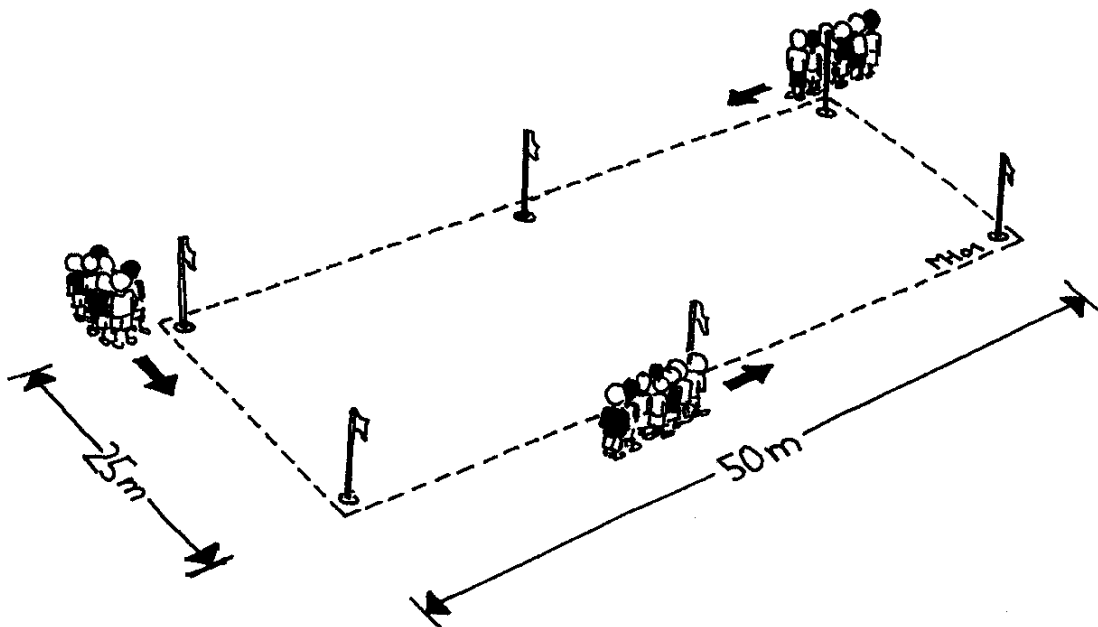
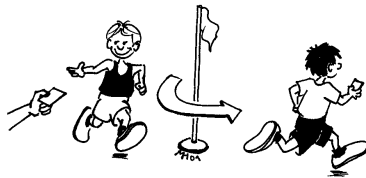

In this event, children will be trying to maintain a regular speed. This will guarantee the good mastery of the exercise.

Educational Card 1: "8" Endurance Race

Objective: To control the running speed

Sample situation: Over a 100-200-m distance, run at varying speed according to the instructions given by the instructor. Maintaining a "regular" speed will be the first requirement.

The beginner's behaviour: Beginners will have great difficulty following the instructions and run at the required regular speed.

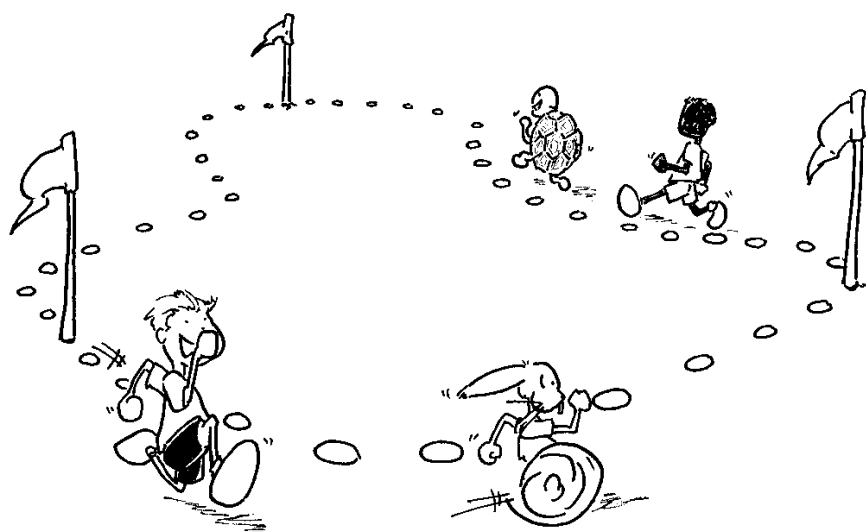

Instructions for the exercise:

- Change the running speed gradually
- Adjust your breathing and breathe "naturally"

Noticeable points:

- Respect the given instructions
- Easy breathing

Teaching progression:

- Run at different paces on each area
- Run various distances
- Run collective races (relay in pairs, American relay, etc.)
- Move towards games

Safety:

- Safe course
- Speed: appropriate to the level of ability signal
- Appropriate length of time for the exercise

Equipment:

- marking implements
- a whistle, or other starting signal

Educational Card 2: "8" Endurance Race

Objective: To regulate one's breathing during physical effort

Sample situation: On an accessible course, the participants experiment different sorts of possible breathing cycles at an average speed.

The beginner's behaviour: Beginners will command their breathing mechanically, and they will have difficulty keeping in step, especially when they exhale.

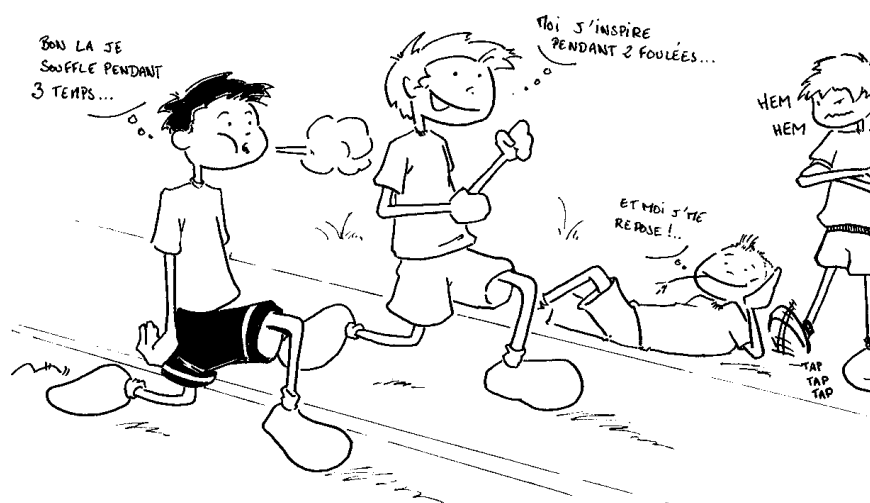

Instructions for the exercise:

- Start with basic breathing cycles
- Sound breathing out

Noticeable points:

- Ability at following the instructions
- No sign of physiological problems

Teaching progression:

- Regulating of different types of breathing cycles
- Run with rhythmic aids
- Run various distances demanding various speeds
- Move towards games

Safety:

- Safe course
- Well-appropriate speed to the levels of ability signal
- Appropriate length of time for the exercise

Equipment:

- Marking implements
- a whistle, or other starting signal

Educational Card 3: "8" Endurance Race

Objective: To find one's own pace

Sample situation: Discovery of a short running-sequence programme, at individual running speed.

Races will be carried out mainly over 100m to 400m distances and they will be repeated 2-4 times to perfect the speed rule (This is more important than merely increase the physical endurance).

The beginner's behaviour: Beginners have difficulty respecting the running sequences at specific speed levels.



Instructions for the exercise:

- Respect the given distances and speed levels
- Keep breathing normally, and remain relaxed

Noticeable points:

- Master the proposed speed levels
- Relative physiological ease
- Watch the signs of physical strain

Teaching progression:

- Every configuration is possible depending on the children's level of ability. The main objective is to have them experiment various forms of physical effort.

Safety:

- Appropriate efforts
- Correct recovery
- Heart controlling
- Watch the signs of physical strain

Equipment:

- Markers
- A stopwatch
- A measuring-tape

Educational Card 4: "8" Endurance Race

Objective: To learn how to run in a group

Proposed situation: Have a group of children complete various races (varied distance and speed) tying them together with a rope (or other implement: band, bicycle tube) or forcing them to run in various groups.

The beginner's behaviour: Face to the problems of the collective race, beginners will respond with a very distinct change of direction or speed. They adjust their pace to the progression of the race at the last possible moment.

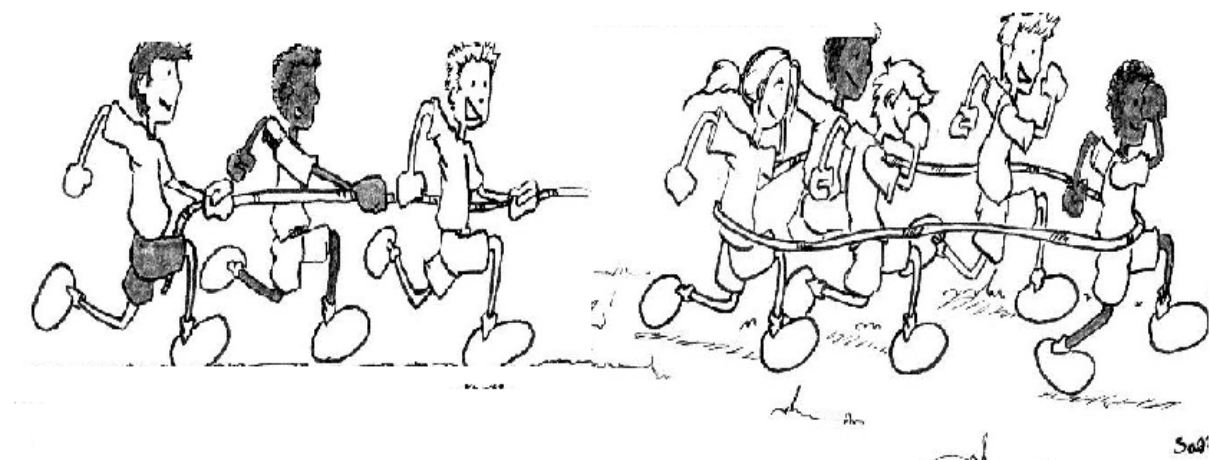

Instructions for the exercise:

- React to the adjustment of the race as soon as possible
- Adjustment by a reduced amplitude of stride
- Keep watching the lead runner

Noticeable points:

- Achieve the required adaptation gradually
- Adjust your stride and the frequency of your pace easily

Teaching progression:

- Vary the courses
- Impose a run at a high speed
- Make the group bigger
- Keep the time
- Move towards games

Safety:

- Safe running area
- Organisation of the group (instructions)
- Keep to the objectives of each exercise

Equipment:

- Vertical markers
- A team link (rubber tube, etc.)

Educational Card 5: "8" Endurance Race

Objective: To learn how to adjust one's stride to another runner's stride

Proposed situation: On different courses, runners will have to adjust their stride to the stride of a team mate, either close by, or further away from him or her.

The beginner's behaviour: Beginners have great difficulty evaluating how fast other participants run, and adapting them. The further apart they are, the more different the courses are, and the more problems beginners will have. They will adapt or try to adapt themselves in the finishing strides.

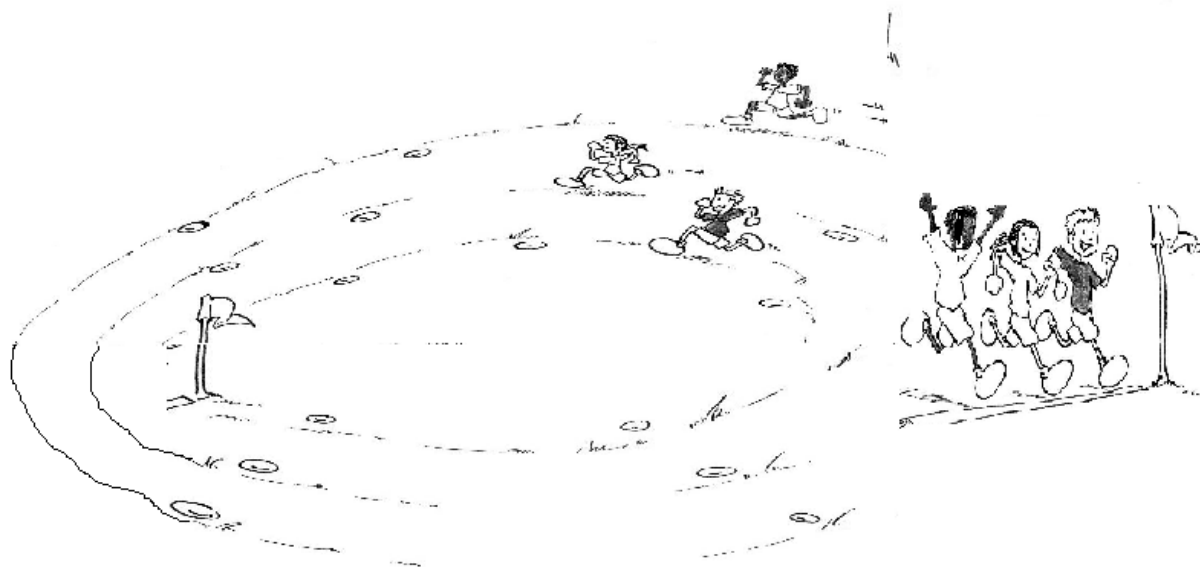

Instructions for this exercise:

- Take as many reference marks as possible as to the runner and his/her background
- Run as regularly as possible

Noticeable points:

- Achievement of the required projects
- Easy adjustment to the running leader
- Easy running stride

Teaching progression:

- Vary the courses
- Vary the positions leader/runner
- Move towards games

Safety:

- Safe course and area
- Organisation of the group (instructions)

Equipment:

- Vertical markers

EDUCATIONAL CARD: FORMULA ONE RACE

Analysis of the situation: the Formula One race is a multifaceted activity combining the forward roll, sprint, slalom and hurdles clearance. Each element could be subjected to groundwork.

Instructions for the safety of the participant: Safe course and equipment, maximum 60-70m distance.

Figure

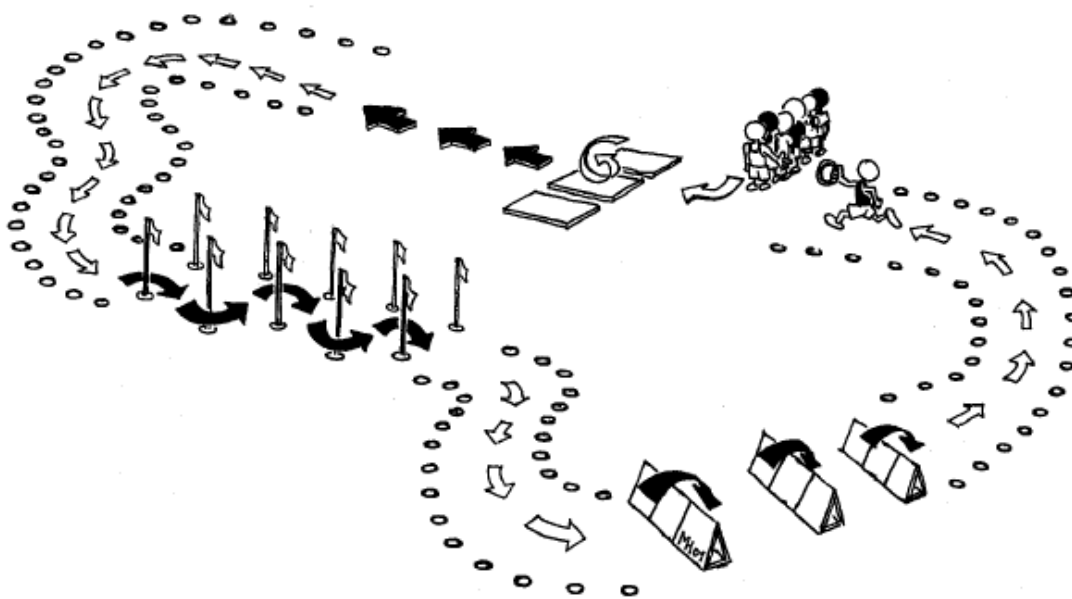

IAAF Kids' Athletics event

Educational Card 1: Formula 1

Objective: Overall experiment of the forward roll

Proposed situations: Complete a forward roll on a sloping surface; this position makes things easier and enables children to assimilate the sequence roll/start. On a soft ground or mats, complete backward rolls, landing on both feet, holding the knees.

The beginner's behaviour: Beginners do not keep the rolling position during the roll; they often stretch their lower limbs which prevents them from landing on their feet.

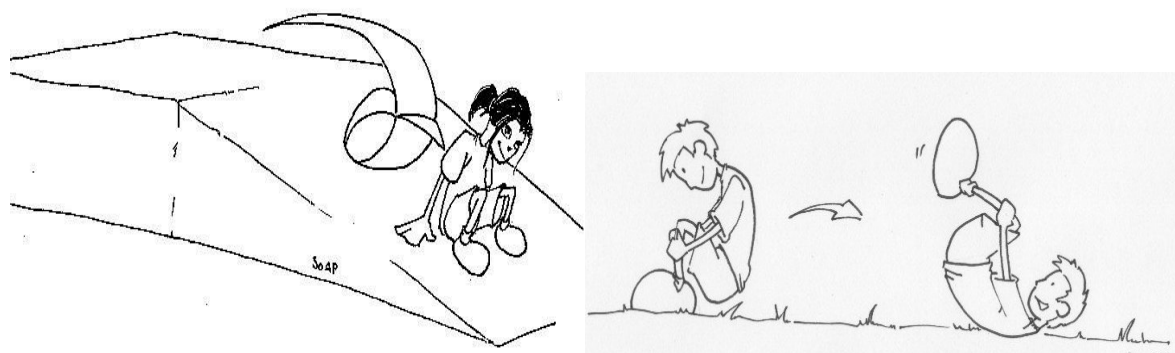

Instructions for the exercise:

- Keep the chin on the chest until the exercise is completed
- Rest on one's hands at the starting line

Criteria for a successful performance:

- Keep the rolling position during the roll
- Maintain the velocity on the two feet landing
- Roll in the direction of the displacement

Teaching progression:

- Vary the sloping surfaces
- Vary the rolls (backward, splits, etc.)
- Vary the starting positions (kneeling, half-kneeling positions, etc.)
- After landing, use the support of the hands
- Move towards games

Safety:

- Appropriate sloping surface
- Strict organisation
- Organisation of the group

Equipment:

- Sloping surface
- Mats

Educational Card 2: Formula 1

Objective: To experiment and master the obstacle clearance

Proposed situation: Have the children carry out running distances with low and indefinite obstacles. Each course will be different; the number of obstacles can vary and be 1 until 10 strides apart.

The beginner's behaviour: Beginners often slow down before the obstacles to adjust their pace and jump over. The landing after the clearance is often completed in the safety position (a two-foot touchdown) preventing from running again.

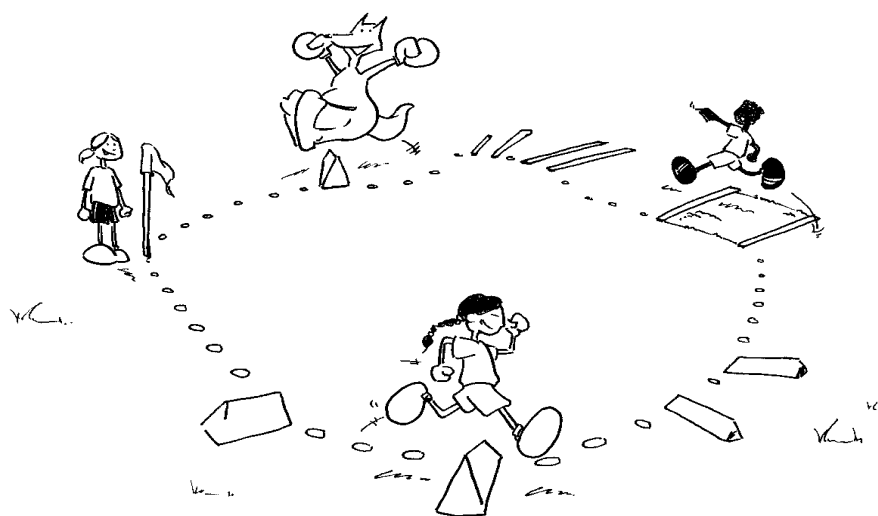

Instructions for the exercise:

- Link up running and getting over the obstacles
- Achieve the clearance with take-off from both feet

Criteria for a successful performance:

- No loss of balance
- No loss of speed as the obstacles approach
- Keep the running position at clearance (arms, general position of the body, etc.)

Teaching progression:

- Vary the courses
- Straight then curved course
- Varying hurdle height (lower range)
- Link up hurdle and "water" jump clearance
- Progress towards games (relays for ex.)

Safety:

- Safe course
- Safe obstacles

Equipment:

- Different kinds of obstacles
- Markers

Educational Card 3: Formula 1

Objective: To experiment and master the sprint slaloming

Proposed situation: Race with varied markers for sprint slaloming: the distance between markers will be varying to experiment all the curves possible.

The beginner's behaviour: Beginners often tend to modify their pace to complete the slalom (point stances out of the direction of displacement, body no longer facing the direction of the race).

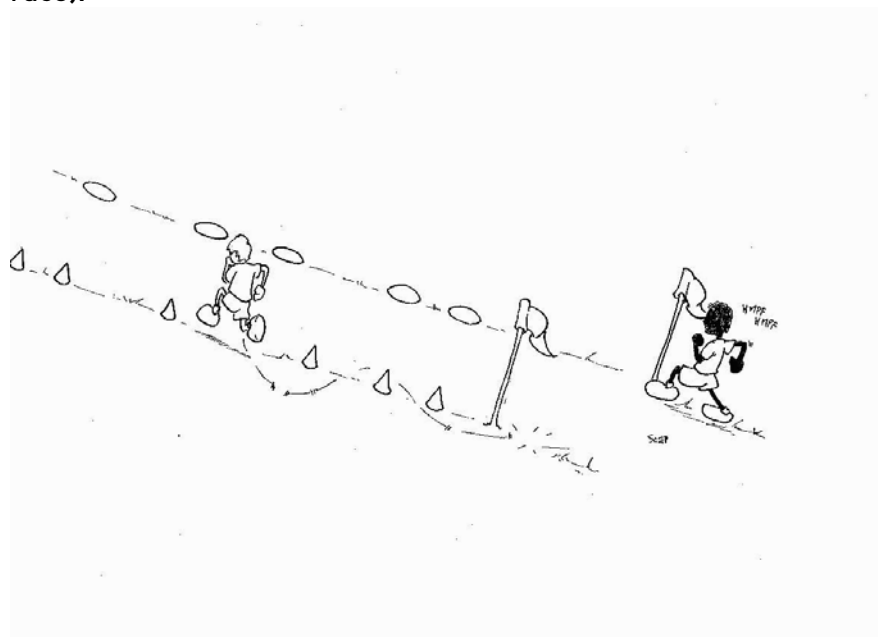

Instructions for the exercise:

- Run as regularly as possible
- Keep facing the direction of the race

Noticeable points:

- Respect the given instructions
- Maintain the body facing the direction of the race
- Maintain the running position (arms, etc.)
- Run fast

Teaching progression:

- Vary the courses at the most
- Vary the field (flat, steep, etc.)
- Vary the velocity
- Move towards games (relay for example)

Safety:

- Safe course
- Organisation of the group

Equipment:

- Markers

Educational Card 4: Formula 1

Objective: To improve the curve running

Proposed situation: On a sprinting mode, react to some instructions in varied situations, achieving curve running distances with a varied radius.

The beginner's behaviour: Beginners will often complete a curve running with decreasing speed quality (arms, point stances). They often run the same curved distance to complete different kinds of curves.



Instructions for the exercise:

- Keep running as regularly as possible in spite of the curves
- Lean inward the curve

Noticeable points:

- Achieve the given exercises
- In the curves, oblique and in-line position of the body
- Similar adjustment in right and left curves

Teaching progression:

- Vary the radius of the curves at the most
- Increase the speed
- Delay the signal announcing the selected curve
- Move towards games

Safety:

- Non-slippery ground
- Organisation of the group

Equipment:

- Vertical markers

Educational Card 5: Formula 1

Objective: To get an efficient starting position

Proposed situation: From various positions of the body, all implying a bent position, the participant will have to perform efficient starts.

The beginner's behaviour: Beginners will tend to stand up before moving into a running position.

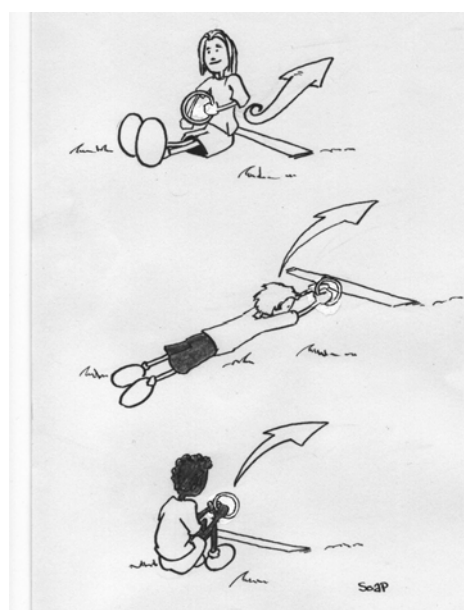
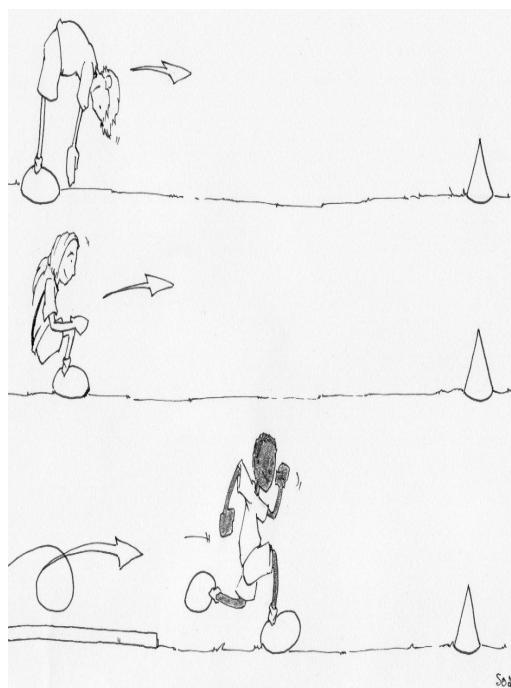

Instructions for the exercise:

- Use the maximum push of the leg to start
- use the instability after the start position to move faster

Noticeable points:

- Lower limbs are fully extended
- Forward loss of balance during the first strides
- Use of the arms to improve the quality of the start

Teaching progression:

- Vary the starting positions at the most
- Keep the time for a 10m distance
- Submit challenges to be taken up
- Move towards games

Safety:

- Non-slippery and soft ground
- Organisation of the group

Equipment:

- Vertical markers
- A stopwatch

EDUCATIONAL CARDS: FORWARD SQUAT JUMP

Analysis of the event: Jumping event which emphasizes not only the strength of the lower limbs, but also the coordination between arms and legs, the symmetrical action of the lower limbs, and finally, the acceptance of the forward instability by the children.

Instructions for the safety of the participants: The safety of the event will be guaranteed by a soft and non-slippery ground and by providing the required instructions for cushioning upon landing (silent).

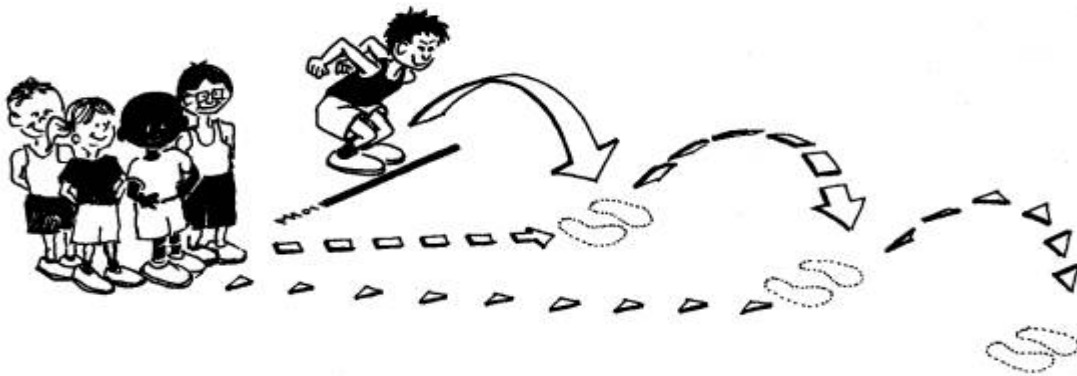

IAAF Kids' Athletics Event

Educational Card 1: Forward squat jump

Objective: To experiment the lower down jump and learn the absorption on the landing phase after the forward squat jump.

Proposed situation: From a box or another above implement, appropriate to the children's abilities (20 cm are enough for a start), complete a jump to land with both feet on the ground.

The beginner's behaviour: Beginners often watch their feet while landing, and often have a "broken" position of the body, without absorption with the lower limbs.

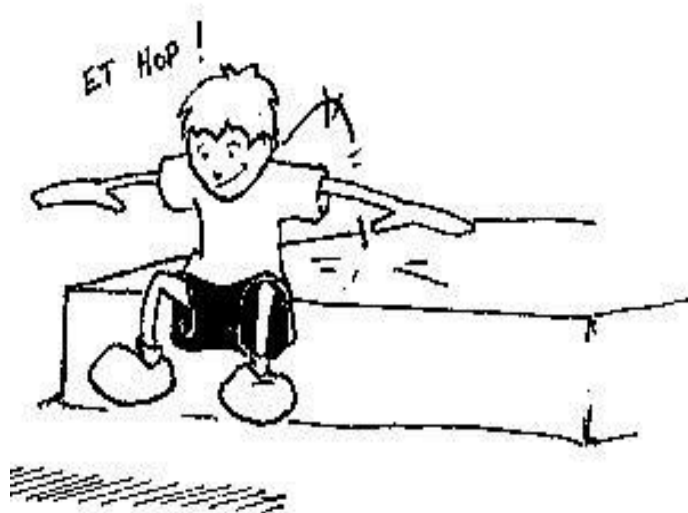

Instructions for the exercise:

- Do not make noise upon landing
- Keep the trunk in a straight position

Criteria for a successful performance:

- Landing on two feet simultaneously
- Absorb the landing with bent legs
- Maintain the trunk in upright position

Teaching progression:

- Achieve jumps on targets
- Link several varied lower down jumps into a sequence
- Jump holding an implement (ball, card, etc.)
- Move towards games

Safety:

- Soft ground
- Stable above structure
- Appropriate height

Equipment:

- An up above structure
- Mats if necessary

Educational Card 2: Forward squat jump

Objective: To experiment the two feet take-off and the lower limbs' bending for an above landing.

Proposed situation: Jump on an appropriate above surface (20 cm are enough for a start) and achieve a stable landing position (measure the take-off and the rotation of the body).

The beginner's behaviour: For safety, beginners tend to anticipate the touchdown on the above surface reducing significantly the take-off with both feet.

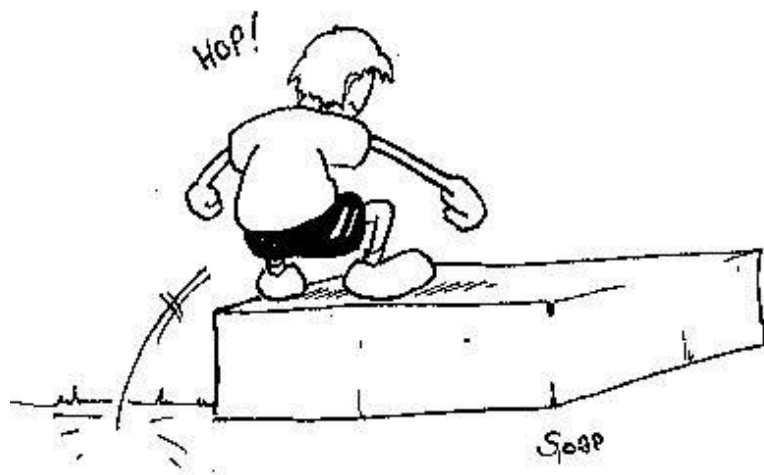

Instructions for the exercise:

- Stand close to the above structure
- Put the feet up before landing

Noticeable points:

- Balanced landing
- Full take-off with lower limbs
- Lightening action of the arms
- The trunk is almost in a vertical position

Teaching progression:

- Vary the height of the above structure (within the bounds of possibility)
- Jump on targets
- Link up jumps and other actions: for example a throw, or a lower down jump, etc.)
- Move towards games

Safety:

- Stable above structure
- Appropriate height

Equipment:

- An up above structure

Educational Card 3: Forward squat jump

Objective: Mastery of varied steady two-footed jumps

Proposed situation: On a hopscotch layout (cross hopscotch for example), the participants carry out jumps to the left, to the right, with rotation, etc.

The beginner's behaviour: Beginners often watch their feet to target the correct landing. They generate the rotation with their shoulders instead of their feet.

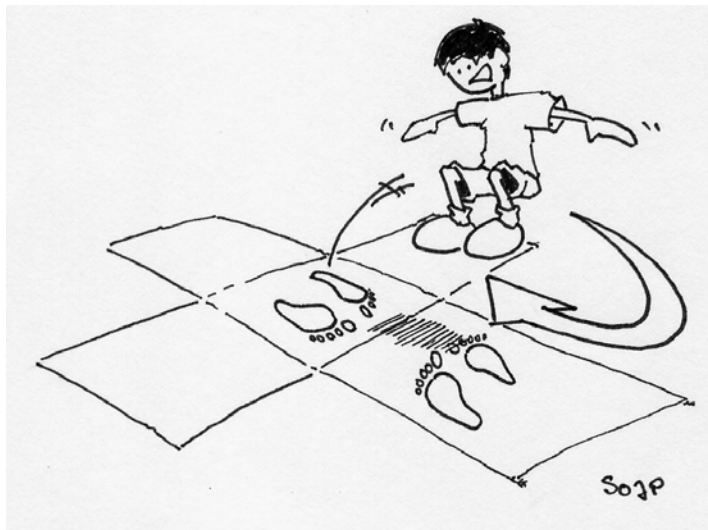

Instructions for the exercise:

- Do not watch your feet
- Vary the rotations R and L

Criteria for a successful performance:

- Complete the required jumps
- Keep balance
- Take-off with two feet simultaneously

Teaching progression:

- Vary the hopscotch layout
- Link two or three jumps together with intermediary stops
- Move towards games

Safety:

- Non-slippery ground
- A clearly visible layout necessary

Equipment:

- Mats if necessary
- Horizontal markers if

Educational Card 4: Forward squat jump

Objective: To learn how to move about with two-footed jumps

Proposed situation: Make as many two-footed forward bounces as possible with amplitude requirements.

The beginner's behaviour: Beginners have difficulty performing several bounces; their lower limbs are often bent too much. The arms have a "stabilizing" effect.

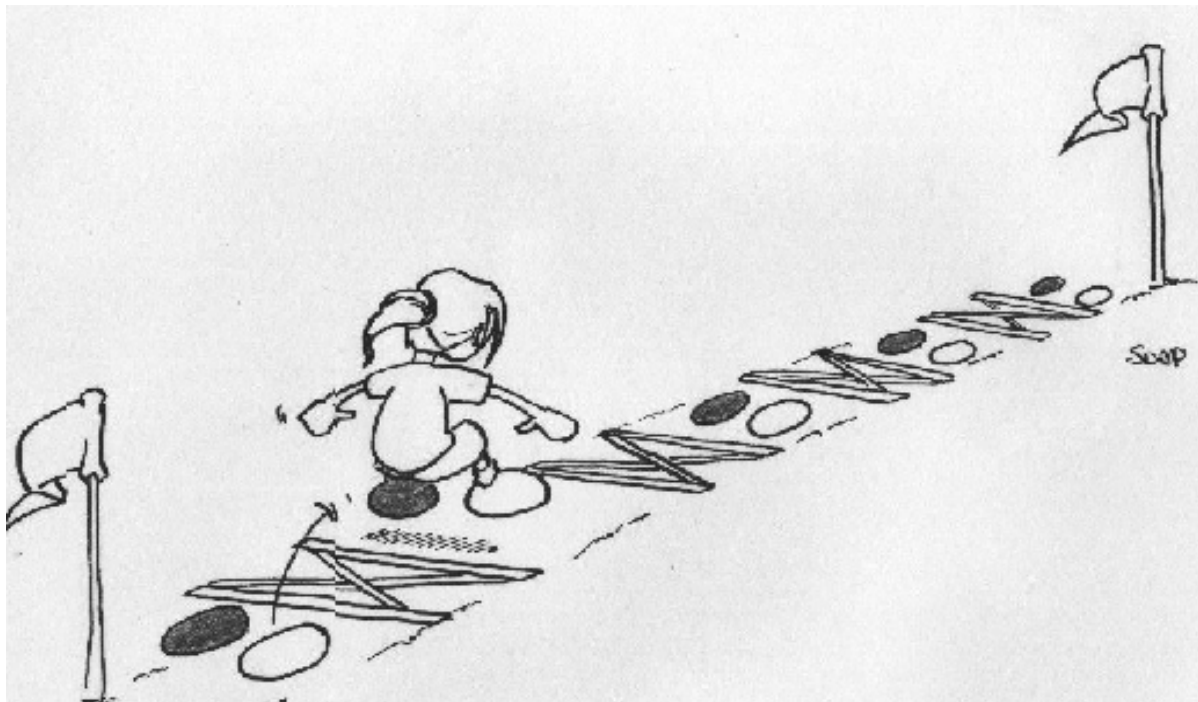

Instructions for the exercise:

- Legs are not too bent
- Use your arms
- Look where you go

Noticeable points:

- The bouncing sequence
- General balance
- Performance

Teaching progression:

- Change the nature of the ground (grass, sand, mats, etc.)
- Vary the amplitude with grids and lines

Safety:

- Soft and non-slippery ground
- Organisation of the group
- Appropriate jumping distance (short)

Equipment:

- Horizontal markers
- Mats

Educational Card 5: Forward squat jump

Objective: To improve the push of the legs

Proposed situation: Have the children carry out a vertical take-off from both feet to touch a given target.

The beginner's behaviour: Beginners do not use the full possibilities of their muscular actions. The sequence of actions is often inefficient.

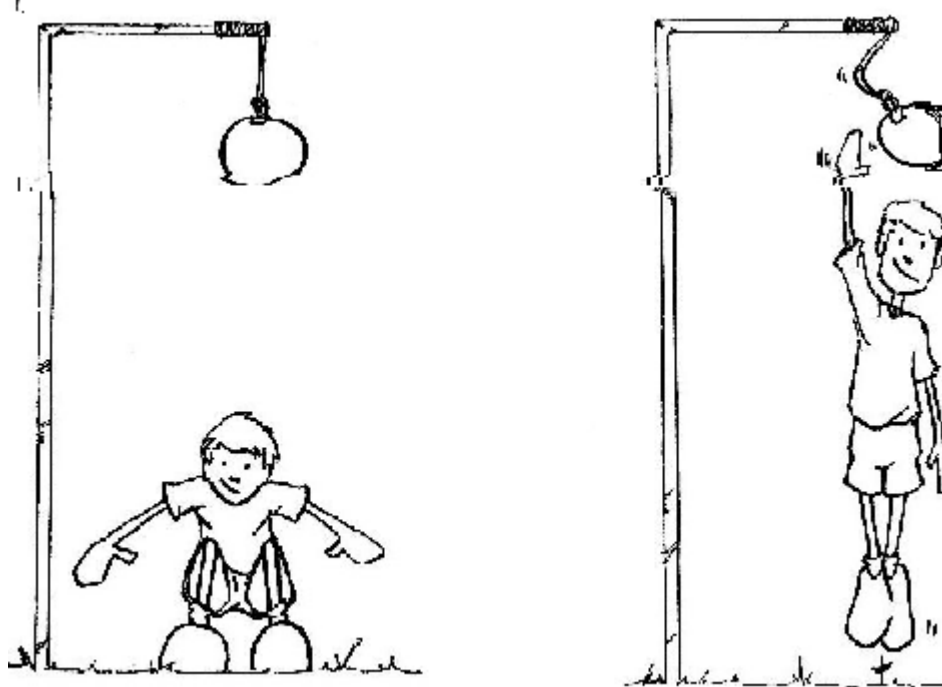

Instructions for the exercise:

- Long push from the leg until the tiptoes
- Carry on with the arms
- Look in front of you while jumping

Noticeable points:

- End with ankles fully extended
- Strictly vertical take-off

Teaching progression:

- Touch the target with the right hand and left hand
- Perform several bounces
- Move towards games

Safety:

- Flat and soft ground
- Safe target

Equipment:

- Targets

EDUCATIONAL CARD: SPEED LADDER

Analysis of the event: the speed ladder event requires competence of precision in the landing of supports at running speed and the ability to create high frequency support.

Instructions for the safety of the participant: Markers on the ground delimiting “the ladder” must be safe. The ground must be soft and non-slippery. A preliminary warming-up session is necessary for this event.

Figure

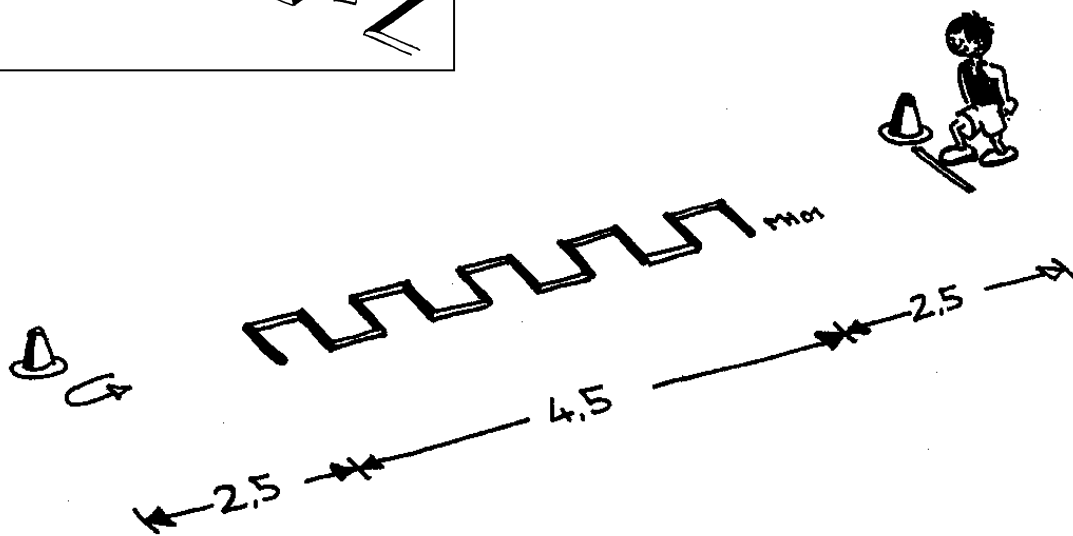
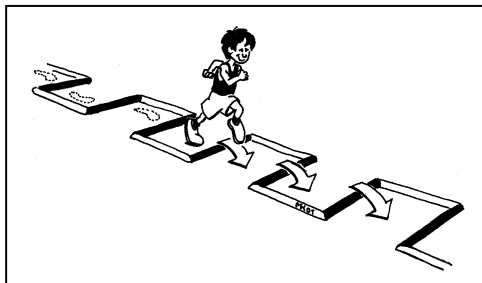

Event from IAAF Kids' Athletics Competition

Educational Card 1: Speed ladder

Objective: Work on the frequency of the take-off

Sample session: Work with a beat box (or music playing) with changing time frequency and adjustment of the take-off to the beat.

The beginner's behaviour: Beginners will put up with the imposed sound frequency, responding in a tense and belated way.

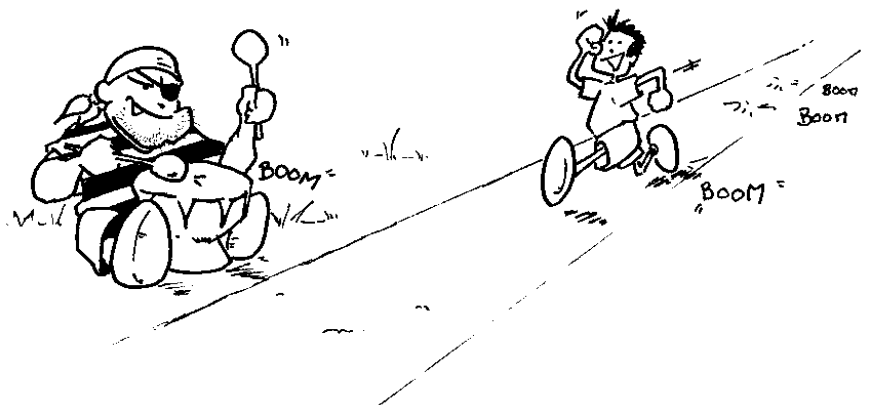

Instructions for the exercise:

- Feel the given beat
- Be relaxed

Noticeable points:

- Follow the required frequency
- Maintain a running speed
- Try to feel the beat rather than think it out

Teaching progression:

- Variety of rhythm and frequency
- Variety of sound even visual aids (team-mates, other)
- Move towards games

Safety:

- Appropriate frequencies
- Organisation of the group

Equipment:

- marked out running area

Educational Card 2: Speed ladder

Objective: To improve the landing precision

Proposed situation: The athletes run distances with crossbars marking a scale of various strides.

The beginner's behaviour: Beginners will have difficulty running on the spaces which are different from their strides. They will often look at their feet and land on their tiptoes.

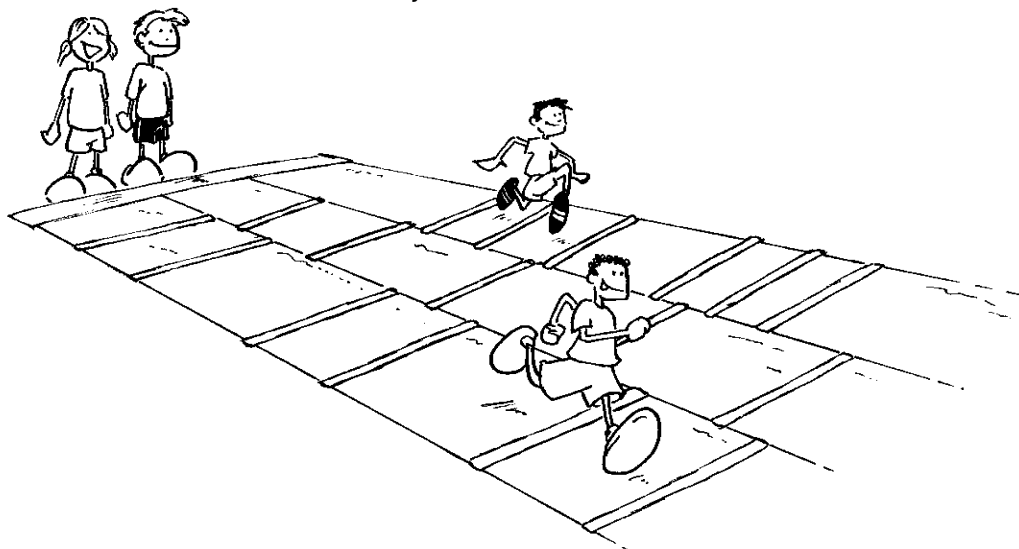

Instructions for this exercise:

- Run as naturally as possible
- Do not look at your feet

Noticeable points:

- Respect the given distances
- Maintain a running speed

Teaching progression:

- Exploit varying speed
- Require take-off from specific support
- Move towards games

Safety:

- Safe markers and ground
- Appropriate spaces
- Organisation of the group

Equipment:

- Horizontal markers
- Vertical markers

Educational Card 3: Speed ladder

Objective: Groundwork for high-frequency strides

Proposed situation: On a slightly sloping footing (2% at the most), manage spaces which get narrower with crossbars. Ask the participants to keep running down at a high speed, and make sure one foot always lands between two successive crossbars.

The beginner's behaviour: Beginners generally do not respect short distances between crossbars and keep striding along at high speed. Their stride will get worse (run on tiptoes).

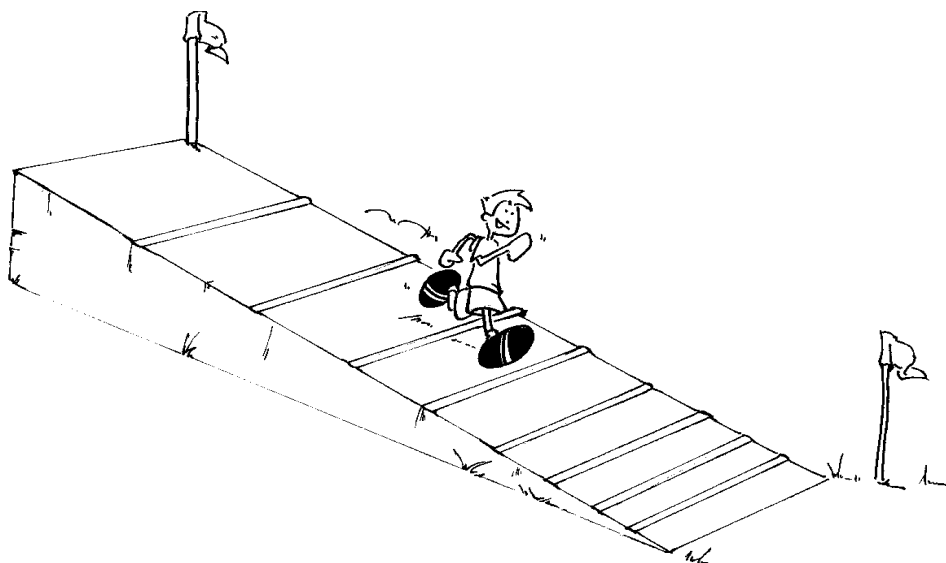

Instructions for the exercise:

- Keep a correct running position
- Look where you are going

Noticeable points:

- Respect the distances
- Maintain a running speed

Teaching progression:

- Vary the working area
- Organise running events with two opponents wrestling
- Move towards games

Safety:

- Appropriate slope
- Keep the finishing area free
- Organisation of the group

Equipment:

- Horizontal markers
- Vertical markers

Educational Card 4: Speed ladder

Objective: To improve about-turns starting from the left and the right sides

Proposed situation: On an 8-m distance delimited with two high blocks, the participants have to shuttle back and forth, touch the blocks (or pick up a tennis-ball over the blocks) once with the right hand, the other with the left hand (turning around the block is allowed).

The beginner's behaviour: Beginners will have difficulty starting again energetically (lack of strength and low position of the body); they are often clumsy when touching the cones.

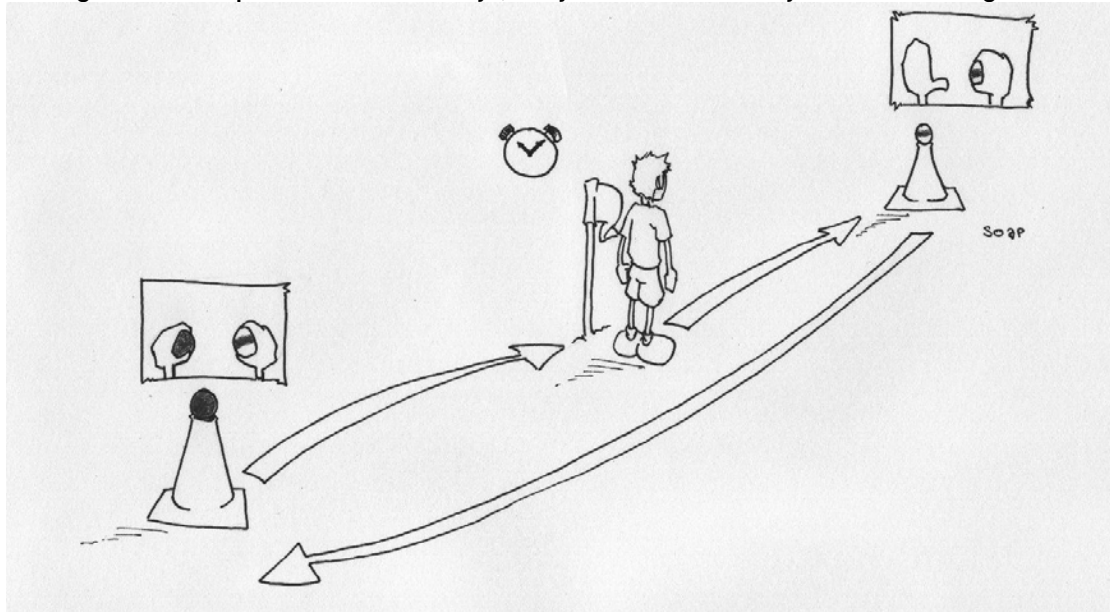

Instructions for the exercise:

- Watch the cones
- Move aside (depending on the touching hand) over the two last strides
- Use your arms to start again

Noticeable points:

- Do not touch the cones with the wrong hand (programme R and L or L and R)
- Do not collapse while starting again after touching the cones

Teaching progression:

- Vary distances and height of cones (not too low)
- Organise running events as duels
- Try to shuttle back and forth with turn around the cone from the right and from the left sides
- Keep the time
- Move towards games

Safety:

- Non-slippery ground
- Cones which are not too low
- Limited number of repetitions

Equipment:

- Cones, blocks
- A stopwatch
- A tennis-ball

Educational Card 5: Speed ladder (as a relay event)

Objective: To ensure an effective changeover

Proposed situation: After a simultaneous face-to-face 10-m apart start, two participants will pass each other still running and will hand over the relay-baton without slowing down.

The beginner's behaviour: The beginner will not be sure about the hand to select for the reception of the baton, he/she tends to stand in front of the giving runner. He/she remains clumsy during the changeover.



Instructions for the exercise:

- Runners move out of line according to the giving runner's position on the side of the relay-baton
- Precise motion of the arm to receive the baton

Noticeable points:

- The relay-baton does not fall down
- Both participants do not slow down
- Constant success of changeovers

Teaching progression:

- Changing hands for both positions
- Achieve the event with increasing speed
- Vary the implements for the changeover
- Keep the time (starting, finishing at the same place)
- Move towards games

Safety:

- Organisation of the group
- Safe relay-baton
- Clear running directions

Equipment:

- Vertical markers
- relay-batons

EDUCATIONAL CARD: CROSS HOP

Analysis of the situation: This event requires mastering the two feet take-off using muscular return. It also demands motor control during a long and organised exercise.

Safety of the participants: The ground must be crumbly, non-slippery and perfectly level. Markers on the areas should be clearly numbered and safe.

Figure

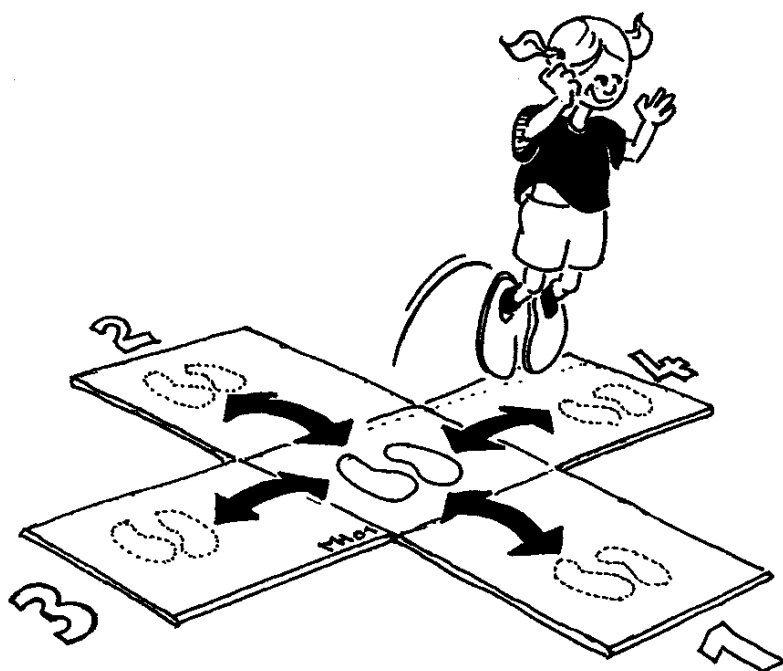

Event from IAAF Kids' Athletics Competition

Educational Card 1: Cross Hop

Objective: To experiment the two feet take-off

Sample session: Playing hopscotch on varied courses, with two feet take-off.

The beginners' behaviour: Beginners watch their feet and often pause while performing two hops: hops are not linked-up.

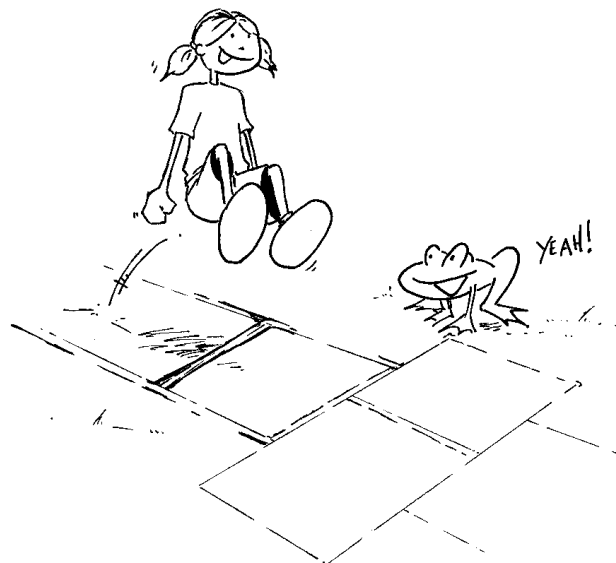

Instructions for the exercise:

- Jumping from both feet
- Take-off from both legs simultaneously

Noticeable points:

- Upright general posture (straight and stable)
- Bouncing with both feet simultaneously
- Use of the arms during the take-off

Teaching progression:

- Working on more and more complex courses
- Experiment different take-off techniques: simple, double, return
- Experiment rotation and balance from the two feet take-off
- Evolution towards playing activities

Safety:

- Non-slippery ground
- Organisation of the group

Equipment:

- Lay-out
- Marked out station

Educational Card 2: Cross Hop

Objective: To control a basic long motor sequence

Proposed situation: Sideways jumps over surmountable obstacles following a “forward” sequence, with systematic return to the starting point 0 (from 0 to 1 and back to 0, then 1 and 2, and back to 0, etc.).

The beginners’ behaviour: Beginners have difficulty hopping from the right to the left (they often bend double). They have trouble memorizing the sequence.

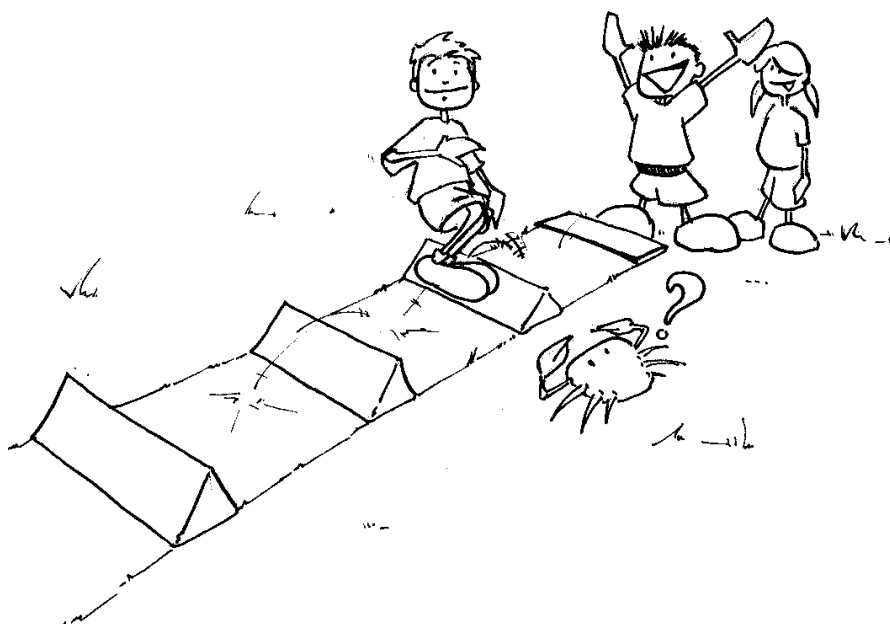

Noticeable points:

- Balance during the exercise
- Work on the muscular hop
- Moving in line with the obstacles
- Straight general posture
- Use of the arms during the take-off

Teaching progression:

- Moving forward, the athletes jump forward, then to the left, then forward, then to the right, etc. through a coordination ladder (“speed ladder”)
- Slalom course with the two feet take-off (cf. ski)
- Course through hoops laid out at random
- Evolution towards playing activities

Safety:

- Non-slippery ground
- Safe and appropriate obstacles
- Organisation of the group (turn)

Equipment:

- Obstacles
- Marked out station

Educational Card 3: Cross Hop

Objective: To improve hopping with rope skipping

Proposed situation: Varied hopping games with a skipping rope (1/1, 1/2, etc.)

The beginners' behaviour: Beginners have difficulty coordinating jumps and their hands' action to move the rope cyclically. They often keep their body leaning forward, bending double from the pelvis.



Instructions for the exercise:

- Keep a standing position
- Do not jump high

Noticeable points:

- Perform varied jumps
- Upright general posture
- Well-coordinated arms-legs

Teaching progression:

- Collective rope skipping (link up Sprint to the skipping field, two-feet take-off, hop over the rope, two-feet landing, Sprint out of the skipping field)
- Work with different intensity and rhythm
- Evolution towards playing activities

Safety:

- Non-slippery ground
- Appropriate skipping rope

Equipment:

- Skipping ropes

Educational Card 4: Cross Hop

Objective: Controlling hops from the right to the left and from the left to the right

Proposed situation: Hopping over a small obstacle from the right to the left and the other way round.

The beginners' behaviour: Beginners tend to hop forward or backward. Their body is often bended from the pelvis.



Instructions for the exercise:

- Look where they are going
- Use of the arms as well to hop

Noticeable points:

- Achievement of the programme
- No forward or backward hopping

Teaching progression:

- Vary hurdles (ever-appropriate width and height)
- Do a standing jump on each side of the hurdle or on one side
- Jump simultaneously with another participant
- Evolution towards playing activities

Safety:

- Non-slippery ground
- Appropriate hurdles and training

Equipment:

- Horizontal markers
- Hurdles / Obstacles

Educational Card 5: Cross Hop

Objective: To master side and forward hops

Proposed situation: Link up jumps, bouncing from the right to the left, and forward over a coordination ladder drawn on the ground.

The beginners' behaviour: Beginners have difficulty memorizing the compulsory programme. They often tend to lose balance while hopping forward.

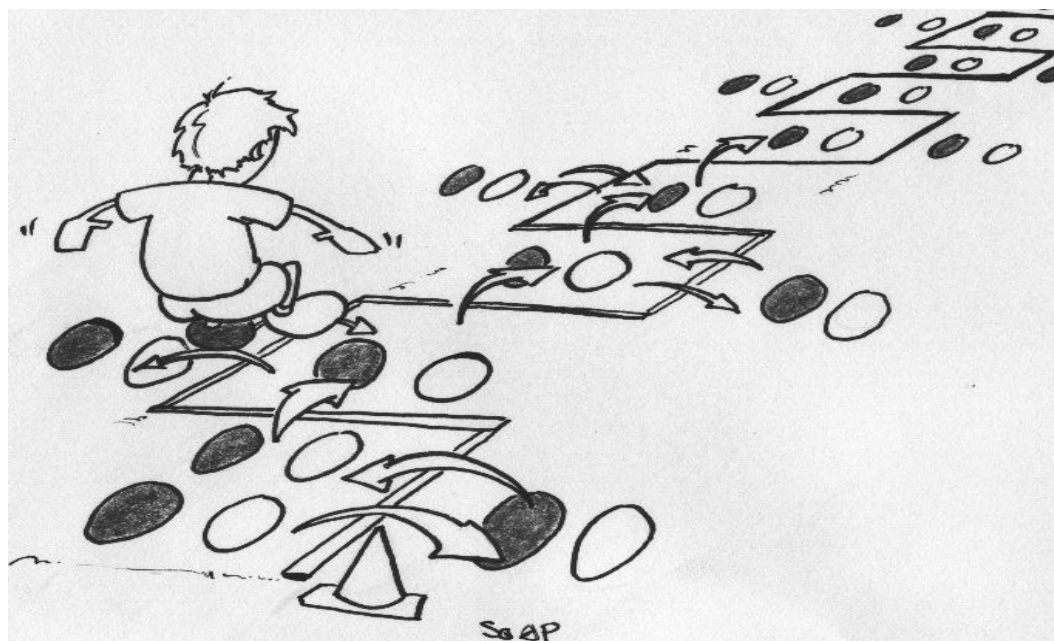

Instructions for the exercise:

- Do not look at your feet
- Limit side and forward movements at the most

Noticeable points:

- Carry out the exercises correctly
- No off-balanced movements
- Use your arms

Teaching progression:

- Vary the forms of obstacles or markers (always appropriate)
- Impose a rhythm to follow
- Keep time
- Evolution towards games

Safety:

- Non-slippery ground
- Appropriate obstacles / venues

Equipment:

- Horizontal markers
- A stopwatch / whistle

EDUCATIONAL CARD: ROPE SKIPPING

Analysis of the event: Practice of coordination between arms/legs and minimum mastery of the take-off from both feet. Control the maximum speed of the movement

Safety of the participants: The exercise must be carried out on a soft and non-slippery ground. The length of the rope must be adjusted to the various participants (= distance from the hand to the ground when the arm is horizontally extended).

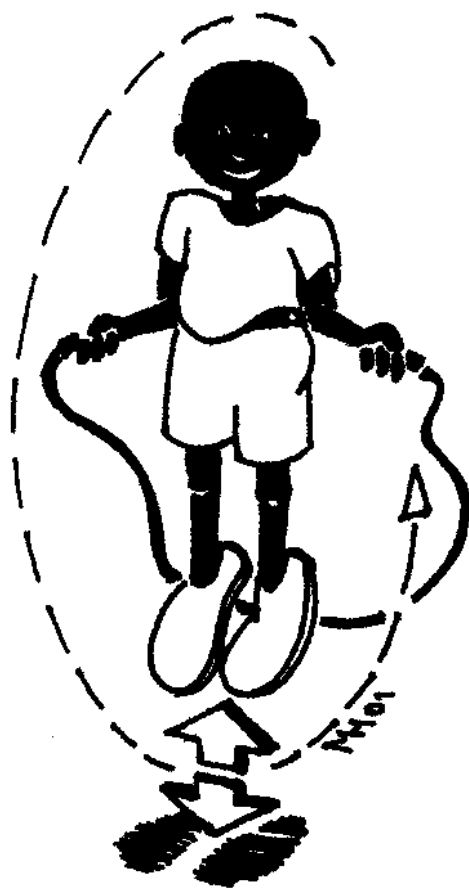

Event from IAAF Kids' Athletics Competition

Educational Card 1: Rope skipping

Objective: To experiment jumping in rope skipping

Proposed situation: Achieve various hops over a rope turned by two participants.

The beginner's behaviour: Beginners often remain in their moving position and do not have any precise idea of the trajectory of the rope. They often jump forwards instead of jumping high only.

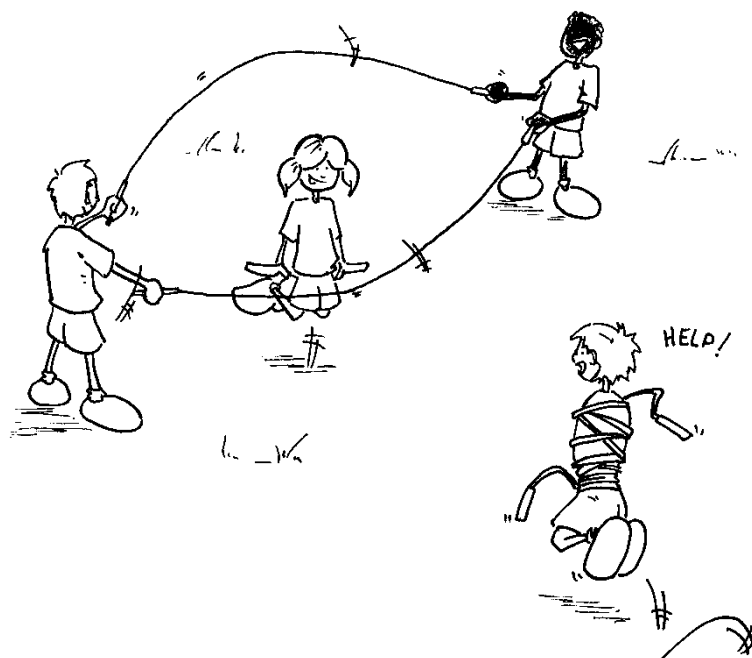

Instructions for the exercise:

- Face the participant who turns the rope
- Jump vertically

Noticeable points:

- Achieve the required hops
- Coordinate arms/legs
- Carry out small hops

Teaching progression:

- Vary the rotational frequency
- Vary the number and forms of jumps (step, hop)
- Entering/getting out of the cyclic process from various points
- Increase the number of ropes
- 2, 3 even 4 children can skip the rope at the same time
- Move towards games

Safety:

- Flat ground
- Watchfulness of the children who turn the rope

Equipment:

- Safe skipping ropes

Educational Card 2: Rope skipping

Objective: To experiment the Jump/Turn coordination

Proposed situation: Hold the rope at both edges with the right hand, and turn it with the wrist. Take-off from both feet each time the rope touches the ground.

The beginner's behaviour: They have difficulty turning the rope and hopping at the same time, and they often carry out hops with the body in a bent position.



Instructions for the exercise:

- Start with low frequency to turn the rope
- Be careful when the rope touches the ground and start hopping
- The rope must be maintained by the wrist
- General upright position of the body (take-off and landing)

Teaching progression:

- Practice with the left hand
- Vary frequency
- Organise moving sequences
- For the oldest or those who have much coordination, practice the rope skipping with extended legs (therefore: foot placement practice only)
- Move towards games

Safety:

- Flat and sound ground
- Organise the group

Equipment:

- Appropriate skipping rope

Educational Card 3: Rope skipping

Objective: To experiment the individual rope skipping

Proposed situation: Holding the skipping rope behind the heels, try to repeat as many hops as possible with two-time rhythm for support.

The beginner's behaviour: Beginners turn the rope and then lean forward to clear it. They often stop turning the rope upon landing.



Instructions for the exercise:

- Begin with low frequency
- Maintain the body in the upright position

Noticeable points:

- Achieve more and more hops
- Save one's strength (choose the right moment and do not jump high)
- Vertical position of the body

Teaching progression:

- Vary the hopping frequency
- Skip the rope in pairs
- Vary the jumping forms
- Generate movement
- For the oldest or those who have much coordination, practice the rope skipping with extended legs (therefore: foot placement practice only)
- Move towards games

Safety:

- Flat and non-slippery ground
- Organisation of the group (space)

Equipment:

- Ropes of appropriate length

Educational Card 4: Rope skipping

Objective: To improve the mastery of rope skipping striding along

Proposed situation: Beginners have to skip the rope over straight courses then various courses, completing two strides between each rotation of the rope (jogging stride).

The beginner's behaviour: Beginners have difficulty during the rotations. They often lean forwards, using the shoulders to turn the rope.

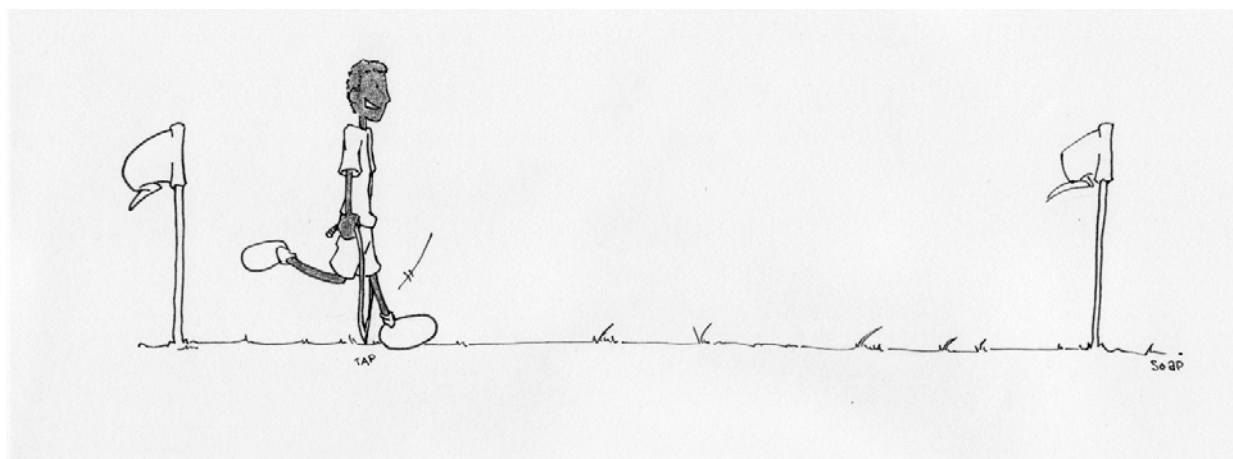

Instructions for the exercise:

- Run and Jump with the body in vertical and straight position
- Block the rope with the wrists
- The eyes look ahead

Noticeable points:

- Complete the required courses
- Maintain the running rhythm
- Remain relaxed during the exercise

Teaching progression:

- Complete different courses (curves, slalom, etc.)
- Jogging from right and left feet
- Move from two feet jumps to jogging jumps
- Skip the rope in pairs
- Move towards games

Safety:

- Organisation of the group
- Appropriate rope length
- Marked out area

Equipment:

- Skipping ropes
- Vertical markers

Educational Card 5: Rope skipping

Objective: To improve the mastery of rope skipping striding along

Proposed situation: Beginners have to skip the rope over straight courses then various courses, with one support between each rotation of the rope (galloping stride).

The beginner's behaviour: Beginners have more difficulty galloping than jogging during the rotations. They often lean forwards, using the shoulders to turn the rope.

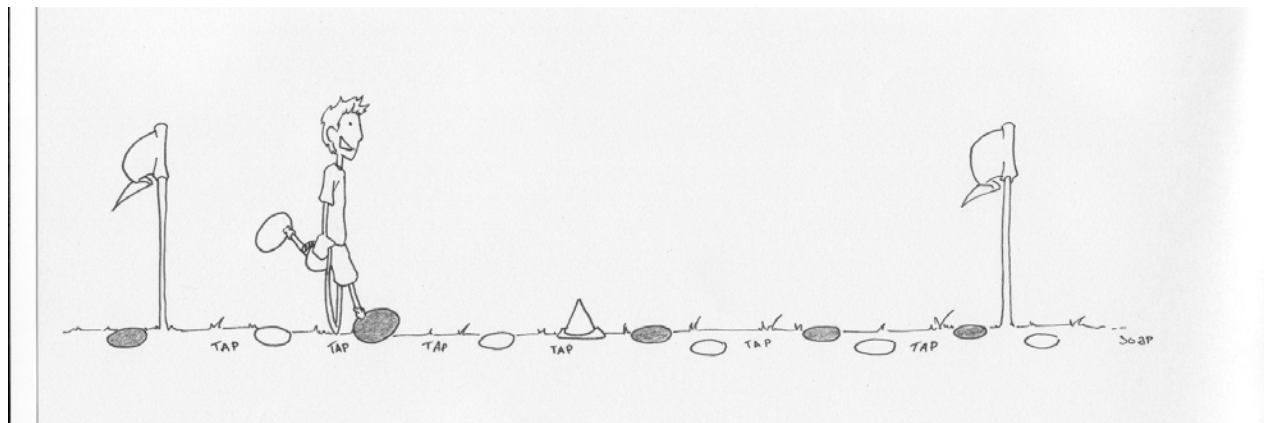

Instructions for the exercise:

- Run/Jump with the body in vertical and straight position
- Block the rope with the wrists
- The eyes look ahead

Noticeable points:

- Complete the required courses
- Maintain the running rhythm
- Remain relaxed during the exercise

Teaching progression:

- Complete different courses (curves, slalom, etc.)
- Change strides, jogging/galloping and galloping/jogging, without stopping
- Move from two feet jumps to galloping jumps
- Skip the rope in pairs
- Move towards games

Safety:

- Organisation of the group
- Appropriate rope length
- Marked-out area

Equipment:

- Skipping ropes
- Vertical markers

EDUCATIONAL CARDS: TRIPLE JUMP WITHIN A LIMITED AREA

Analysis of the jumping practice: The triple jump within a limited area requires a minimum mastery of precision in the run-up, the jumping technique, and the hop/step sequence.

The hop/step practice is efficient to discover the support balance.

Safety of the participants: There are two guarantees for safety:

- Carry out the jumping exercises on a soft and non-slippery ground.
- Direct the practicing efforts to the technical mastery first, before working on the performance.

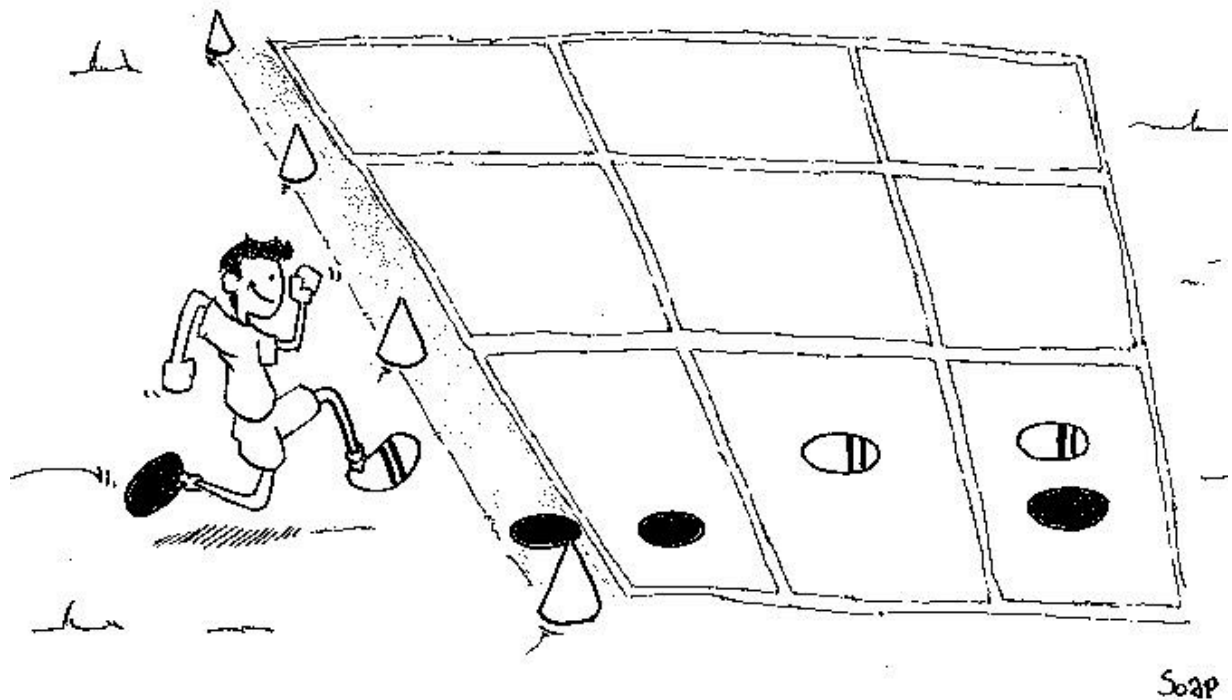

Event from the IAAF Kids' Athletics Competition

NB: In all training situations for multiple jumping events, "the jumping regularity" will be the priority.

Educational Card 1: Limited Triple Jump

Objective: To improve the take-off precision

Proposed situation: Complete forward jumps with a short run-up to improve precision in the support placement. The obstacles will be mainly horizontal so as not to force the participants to jump high.

The beginner's behaviour: To gain precision, beginners slow down before the jumping area and look at the ground, turning aside from the regular general jumping behaviour.

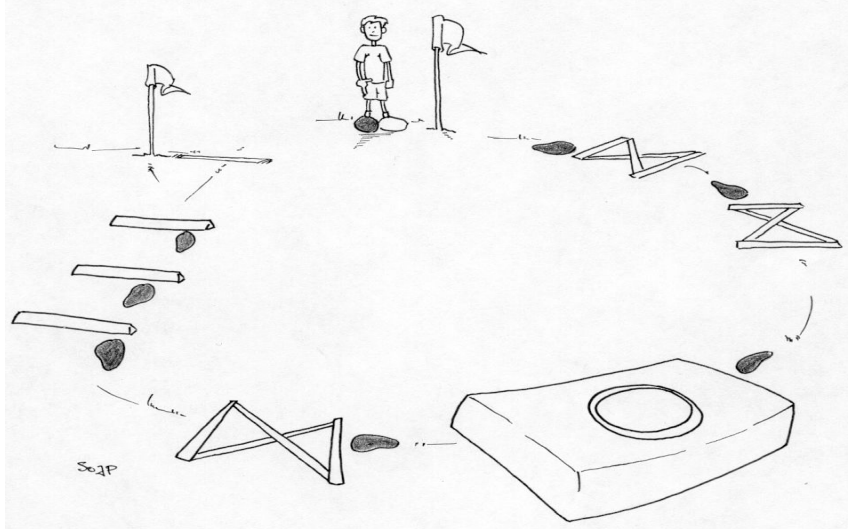

Instructions for the exercise:

- Do not look at the ground
- Link the jumping and the running phases into a whole sequence

Noticeable points:

- Precise foot placement
- No loss of speed before jumping
- Landing at running speed

Teaching progression:

- Vary the distances between rivers (keep short distance – 10m)
- Modify the width of rivers when possible
- Carry out take-off from the right foot and the left foot
- Carry out landing on right foot hopping and left foot hopping
- Move towards games

Safety:

- Soft ground
- Safe and non-slippery markers

Equipment:

- Jumping markers
- Markers on the course

*** This training situation is valid for the short run-up triple jumping event and the short run-up long jumping event.**

Educational Card 2: Limited Triple Jump

Objective: To experiment and master the jumping technique

Proposed situation: Discover and improve the hopping technique through various sequences of exercises. First, the jumping area will be limited for a better achievement.
Example: Hopping sequence over a whole marked-out distance.

The beginner's behaviour: Once beginners faced the basic coordination problem of the hopping technique, they very often lose balance sideways while hopping as the body weight is not over the support leg. They often do not coordinate their arms with the hops and "block" them to gain balance.

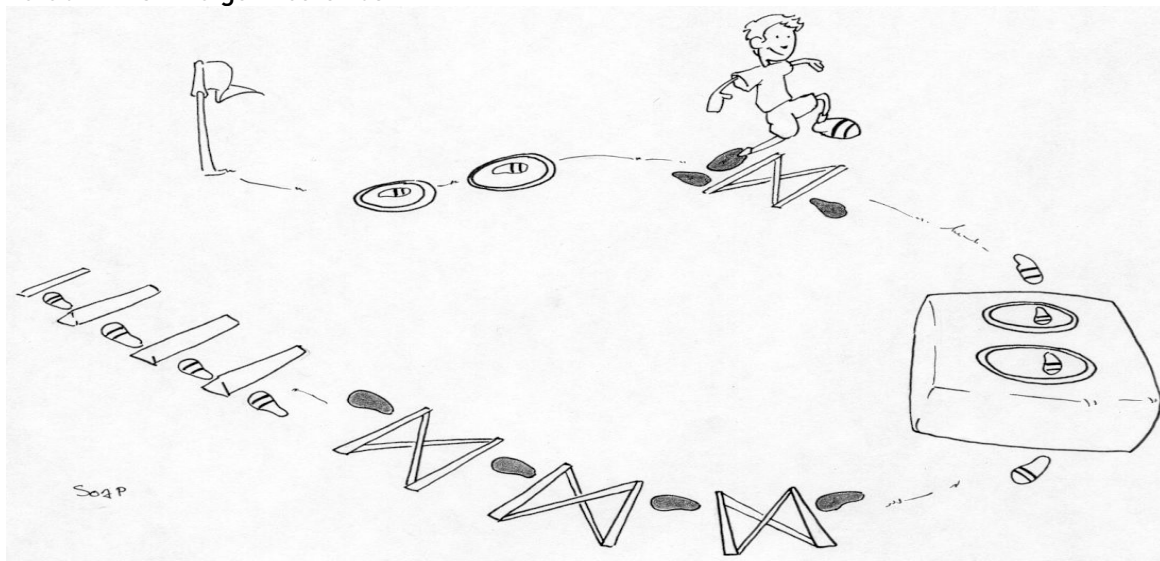

Instructions for the exercise:

- Get over ground support
- Use your arms to move ahead

Noticeable points:

- The athlete is able to bounce (so: good placement on first touchdown)
- The athlete keeps a balanced position while hopping and after the hop

Teaching progression:

- Vary the courses
- Offer various distances following an increasing scale
- Repeat several hops
- Move towards games

Safety:

- Soft ground
- Safe obstacles (course)

Equipment:

- Horizontal markers (obstacles)
- Vertical markers (for the

*** This training situation is valid for the short run-up triple jumping event and the short run-up long jumping event.**

Educational Card 3: Limited Triple Jump

Objective: To experiment and master the hop/step sequence without loss of speed

Proposed situation: Achieve hop/step sequences within various limited spaces at various speed.

The beginner's behaviour: Beginners often carry out small hops and big steps. They often deviate from the correct jumping trajectory because they lose balance in the hopping action. They do not use or misuse the free segments (arms and legs) to move forward.

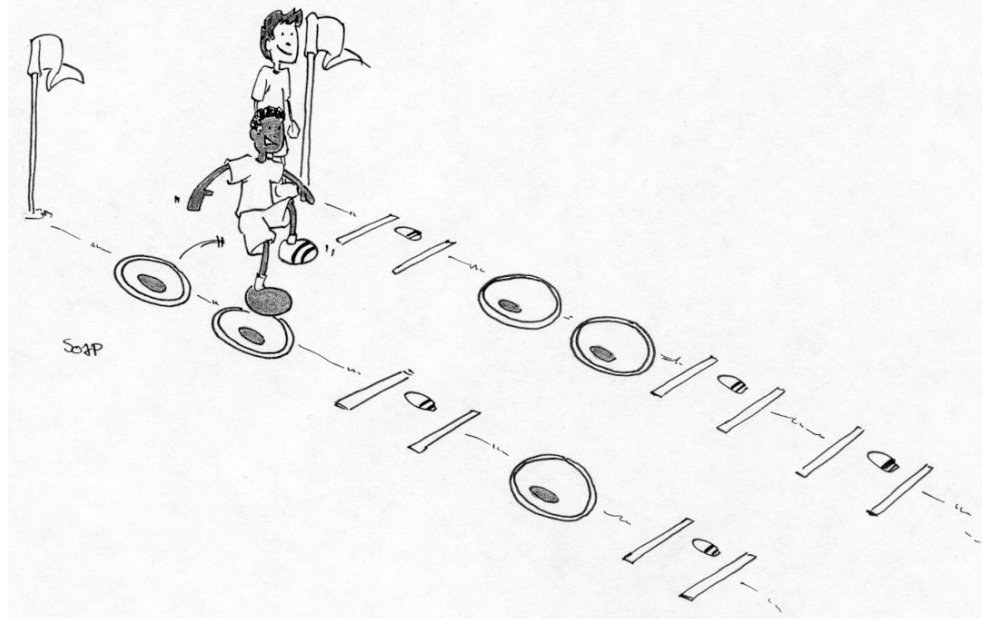

Instructions for the exercise:

- No break between hops and steps
- Do not collapse fall while jumping

Noticeable points:

- Complete the jumping sequence in a balanced position
- Complete the jumping sequence without loss of speed
- Appropriate use of the free segments

Teaching progression:

- Vary the jumping sequence (double hop, step and double step hop, etc.)
- Require synchronization then de-synchronization of the arms: alternatively and simultaneously)
- Vary the practicing areas and the distances between jumps
- Move towards games

Safety:

- Soft ground
- Safe equipment

Equipment:

- Horizontal markers (jumping area)
- Markers for the course

*** This training situation is valid for the short run-up triple jumping event and the short run-up long jumping event.**

Educational Card 4: Limited Triple Jump

Objective: Efficient use of the arms in the jumping technique

Proposed situation: Completing hop/step sequences, try to coordinate the arms in different ways (simultaneous, synchronized, alternative with lower limbs).

The beginner's behaviour: Beginners have great difficulty coordinating the action of their arms with each support. Their arms often generate balance more than action.

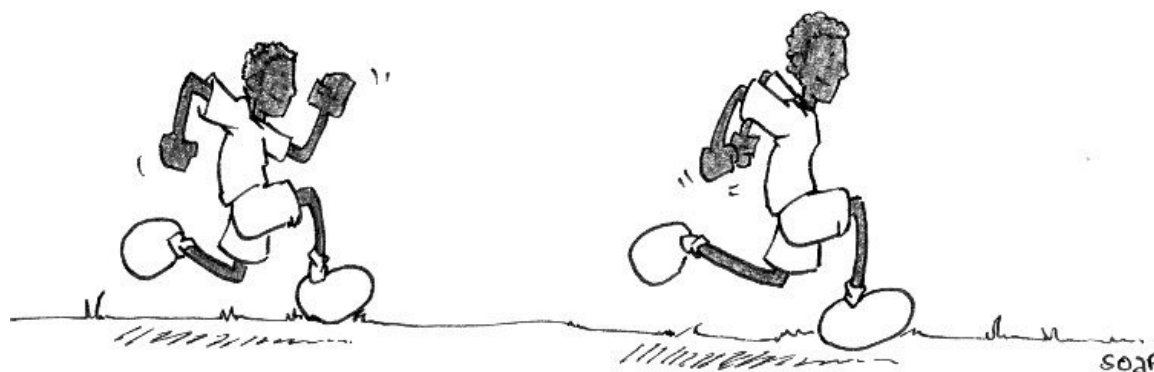

Instructions for the exercise:

- Start with small bouncing areas
- Practice with relaxed arms and shoulders

Noticeable points:

- Achievement of the required programme
- Good general balance during the jumping sequences
- Similar efficiency in both arms practicing formula

Teaching progression:

- Vary the courses
- Vary the spaces
- Link alternative practicing and synchronized practicing
- Move towards games

Safety:

- Soft ground
- Appropriate jumping areas

Equipment:

- Horizontal markers
- Vertical markers

*** This training situation is valid for the short run-up triple jumping event and the short run-up long jumping event.**

Educational Card 5: Limited Triple Jump

Objective: To set the measures for a short run-up

Proposed situation: From a distance marked out every 20m, the participant tries to organise a precise run-up to take-off near the take-off board.

The beginner's behaviour: Beginners have difficulty repeating similar run-ups. They are weak in adjusting their last strides to the remaining distance.



Instructions for the exercise :

- Vary the starting areas to find your own run-up distance
- Try to maintain a regular run from one trial to another

Noticeable points:

- Precise take-off
- Land on take-off foot
- Do not slow down nearing the take-off board

Teaching progression:

- Slightly modify the spaces proposed
- Place an intermediary marker at midway of the area

Safety: Equipment:

- Soft landing area Markers, crossbars
- Organised group A measuring tape
- Appropriate run-up areas

*** This training situation is valid for the short run-up triple jumping event and the short run-up long jumping event.**

EDUCATIONAL CARDS: KIDS' JAVELIN THROW

Analysis of the situation: The throwing event requires commanding both trajectory and performance with one bent arm after taking a short run-up.

Safety of the participants: The retained implements and the objective of precision should solve the safety problem. However, it is recommended to organise the group, time and space, to make the participants aware of the safety rules during a throwing sequence.

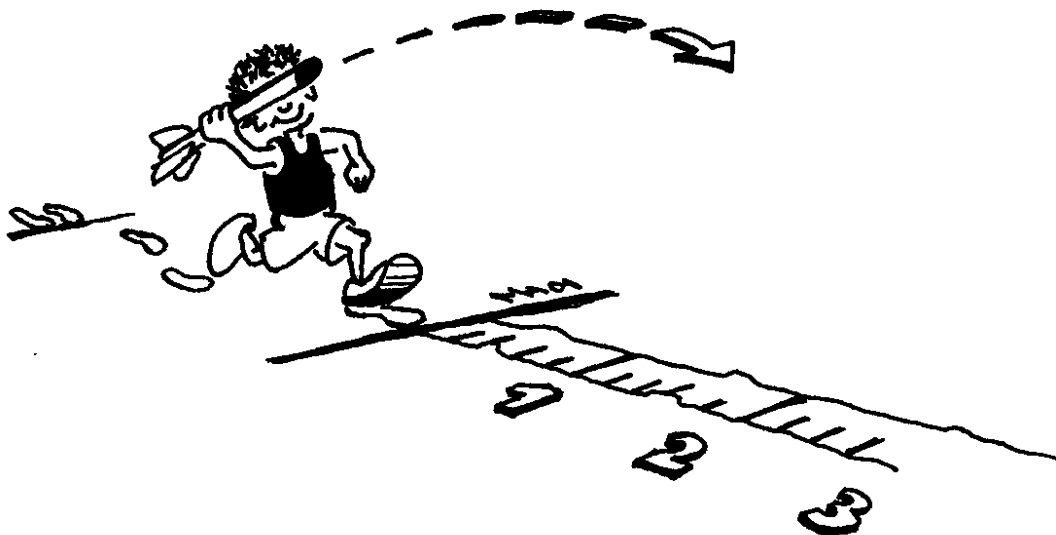

Event from IAAF Kids' Athletics Competition

Educational Card 1: Kids' Javelin Throw

Objective: To experiment the throw with one bent arm

Proposed situation: Throw a safe and light implement (0,5kg maximum) at a target with one arm, from a standing position, both feet being parallel. The throwing arm should be maintained high above the shoulder level.

The beginner's behaviour: Beginners generate flexing and turning movements of the body, which are harmful to the preciseness of the throw.

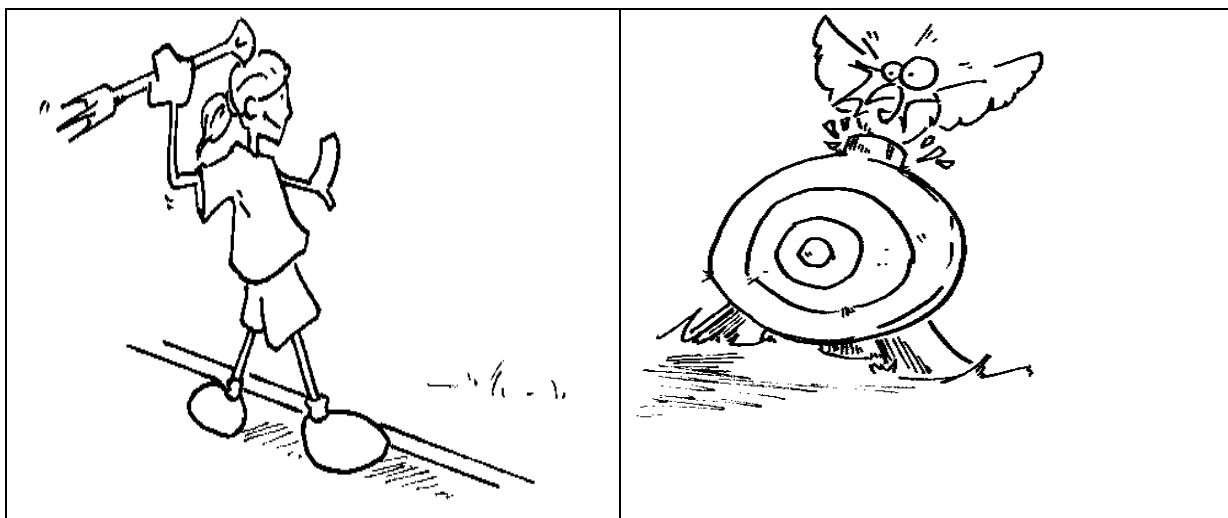

Instructions for the exercise:

- Keep the body's axis in a straight line
- Remain face to the target, the eyes looking at the target
- The throwing arm draws above the shoulder

Noticeable points:

- Correct position of the body (the pelvis is fixed)
- Maintain the arm above the horizontal level of the shoulder
- Use of the elasticity of the shoulder

Teaching progression:

- Vary the light implements
- Vary the targets
- Proceed to exercises like individual or collective games

Safety:

- Use safe implements
- Organise the group
- Organise the running of the exercise

Equipment:

- Various throwing implements
- Targets

Educational Card 2: Kids' Javelin Throw

Objective: To improve the run-up command

Proposed situation: After 3 walking steps carry out a football throw into touch with a ball, or a light medicine ball.

The beginner's behaviour: Beginners will stop before throwing, and their pelvis will move backwards upon the acceleration of the medicine ball.

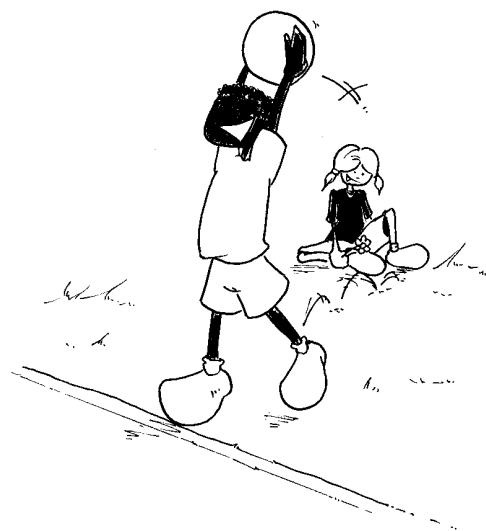

Instructions for the exercise:

- Throw from a left foot take-off (for a right-handed thrower)
- Keep the ball high above the head

Noticeable points:

- Do not stop and throw
- Move forwards after the delivery
- Keep facing the direction of the throw
- Keep the hands high above the head to throw

Teaching progression:

- Vary the trajectories (high, low, straight, etc.)
- Practice take-off from both sides
- Move towards games

Safety:

- Use safe implements
- Organise the group
- Organise the running of the exercise
- Flat ground

Equipment:

- Various throwing implements
- Targets

Educational Card 3: Kids' Javelin Throw

Objective: Preciseness of the trajectory

Proposed situation: After walking steps, carry out a sequence of 3 throws at a target, with one bent arm, of light and various implements; or throw 3 similar implements at 3 different targets (the weight of the implements is 0,5kg at the most).

The beginner's behaviour: Beginners have difficulty adjusting to a throw under new conditions (implements; distance): great imprecision for this throwing practice.



Instructions for the exercise:

- Do not deform one's body while throwing
- Remain face to the target, the eyes looking at the target

Noticeable points:

- Reach the target
- Keep facing the direction of the throw
- Do not stop and throw
- Move forwards after the delivery

Teaching progression:

- Vary the throwing forms
- Vary the targets
- Vary the sequences
- Move towards games

Safety:

- Use safe implements
- Organise the group
- Organise the running of the exercise
- Flat ground

Equipment:

- Various throwing implements
- Targets

Educational Card 4: Kids' Javelin Throw

Objective: To experiment the run-up with crossover strides

Proposed situation: The participants carry out several distance sequences in a side position, holding the kids' javelin.

The beginner's behaviour: Crossover strides are unknown for beginners who will have difficulty adjusting the crossovers strides, particularly from the "bad" foot. They will completely forget to command the javelin (The javelin sways from side to side and leaves the direction of the throw).

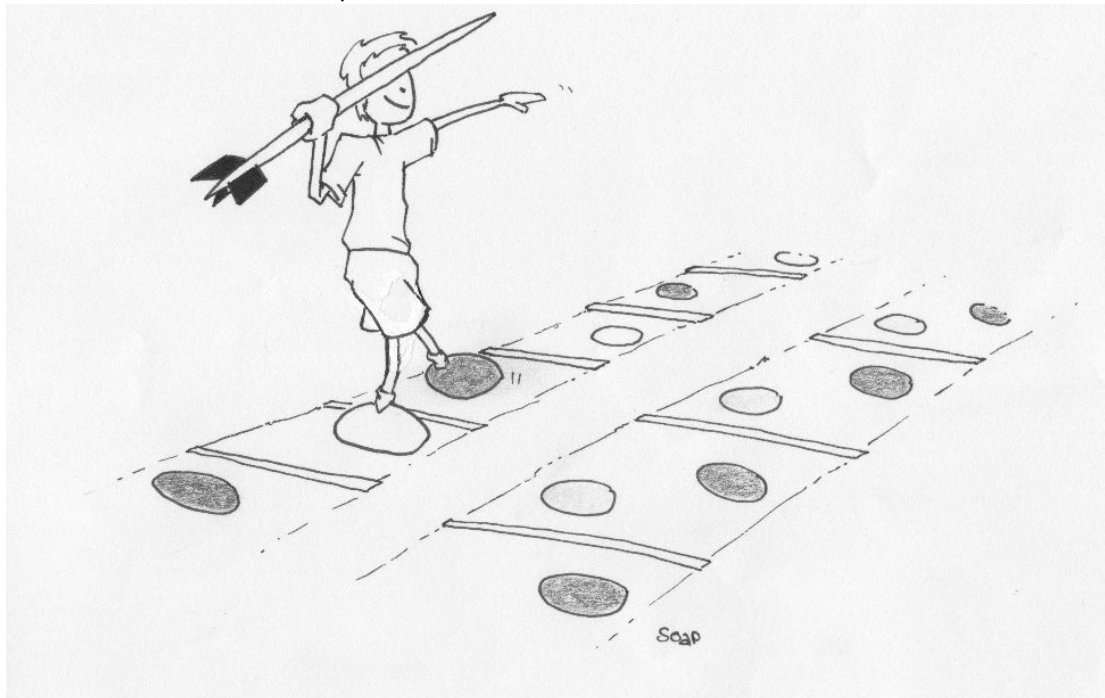

Instructions for the exercise:

- Hold the javelin in the direction of the throw
- Try to achieve efficient strides

Noticeable points:

- Carry out crossover strides easily
- The javelin is steady and in the direction of the throw

Teaching progression:

- Vary the distances
- Clear water (little rivers)
- Use a longer javelin

Safety:

- Organisation of the group
- Clear markers on throwing practice area

Equipment:

- Different javelins
- Vertical markers

Educational Card 5: Kids' Javelin Throw

Objective: To organise a complete throwing movement with a short run-up

Proposed situation: Achieve a running throw at a marked out area: taking a 5-m run-up, targets being at a 10, 15, and 20-m distance (handy and light implements of 0,5kg maximum).

The beginner's behaviour: Beginners find it hard to link the run-up and the throw into a complete movement. The side run-up entails little precision of the trajectories.

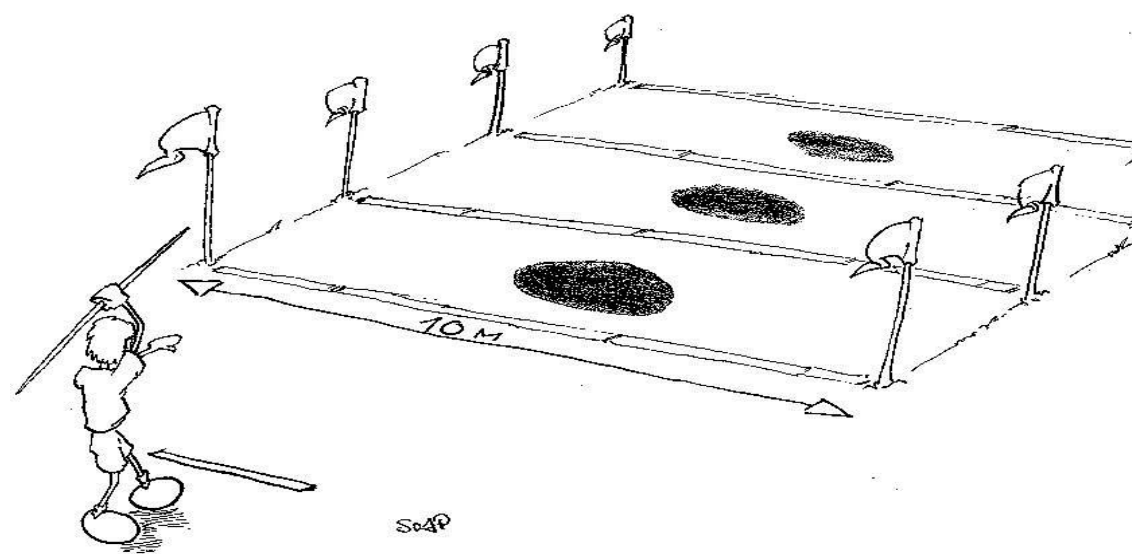

Instructions for the exercise:

- Take a regular run-up
- In the delivery phase, remain front to the targets

Noticeable points:

- Correct trajectories
- Transfer weight to the support leg, the body leans forwards in the direction of the throw
- The javelin is thrown high above the throwing area and the body is in line position

Teaching progression:

- Vary the targets distance
- Vary the javelins

Safety:

- Organisation of the group
- Marked out area

Equipment:

- Different javelins
- Vertical markers

EDUCATIONAL CARDS: KNEE THROW

Analysis of the situation: This throwing event enables the young athletes to experiment from an easy position the strength transmitted by the hip and the prerequisite stretching of the shoulders.

Safety of the participants: The athletes kneel on a soft ground (a mat, sand, grass). Adjust the weight of the medicine ball: always choose the lighter (1kg, 1,5kg).

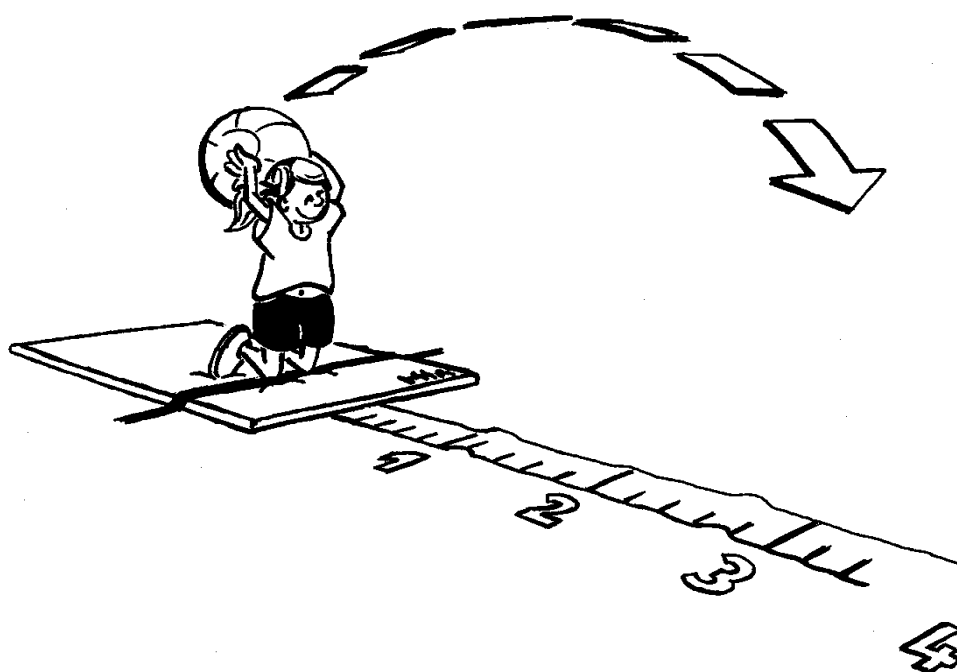

Event from Kids' Athletics Competition
IAAF Figure

Educational Card 1: Knee Throw

Objective: To experiment the throwing activity from any position other than standing

Proposed situation: From a sitting position on an above implement, move the upper half of the body to initiate the acceleration of an object thrown towards a target (a light implement: maximum 1kg).

The beginner's behaviour: Beginners often look for their energy with deformed movements of the body. This is detrimental to the precision of the throw.



Instructions for the exercise:

- Sitting in a balanced/stable position
- Hold the throwing implement firmly

Noticeable points:

- The trunk initiates a long and continuous acceleration
- Coordinate trunk/arms
- Precise trajectories

Teaching progression:

- Vary the implements
- Vary the distances and trajectories
- Vary the position of the throwing object (overhead, at the chest level, from the R/L sides)
- Proceed to exercises like individual or collective games

Safety:

- stable "seats"
- Organise the group
- Safe throwing objects
- Priority is given to precision

Equipment:

- Seats
- Various throwing implements
- Targets

Educational Card 2: Knee Throw

Objective: To improve the throwing action with the top of the body

Proposed situation: Kneeling on one knee, move the upper half of the body to initiate the acceleration of an object thrown to a target (use a light implement of 1kg maximum).

The beginner's behaviour: Beginners often lose balance during the throw.

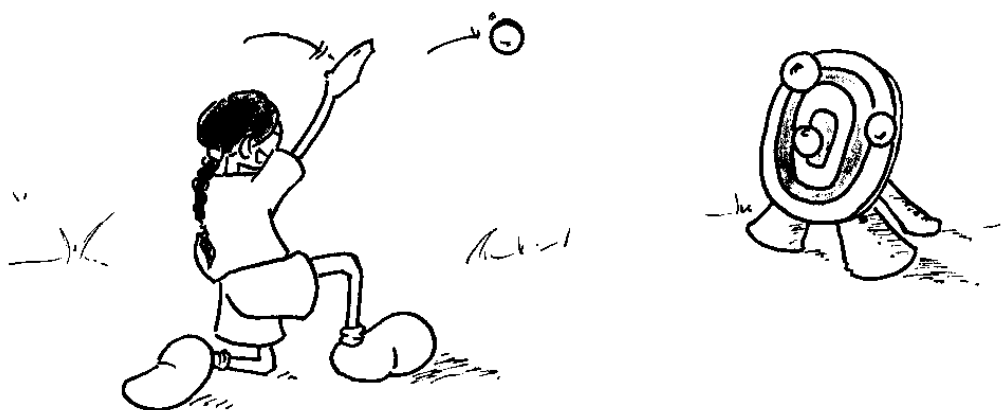

Instructions for the exercise:

- Maintain a well-balanced position
- Block the pelvis during the throw

Noticeable points:

- The trunk initiates a long and continuous acceleration
- Coordinate trunk/arms
- Precise trajectories

Teaching progression:

- Vary the implements
- Vary the distances and trajectories
- Vary the position of the throwing object (overhead, at the chest level, from the R/L sides)
- Proceed to exercises more like games

Safety:

- Soft ground for the kneeling position
- Organise the group
- Safe throwing implements
- Priority is given to precision

Equipment:

- Mats if necessary
- Various throwing implements
- Targets

Educational Card 3: Knee Throw

Objective: To learn how to generate strength with the lower limbs

Proposed situation: Starting from a sitting position, the participants have to move their knees forward, and carry out a throw with the action of their lower limbs (implement of 2kg maximum).

The beginner's behaviour: Beginners often anticipate the action of their arms. Most of the time they entail a backward movement from the pelvis during the body's stretching.

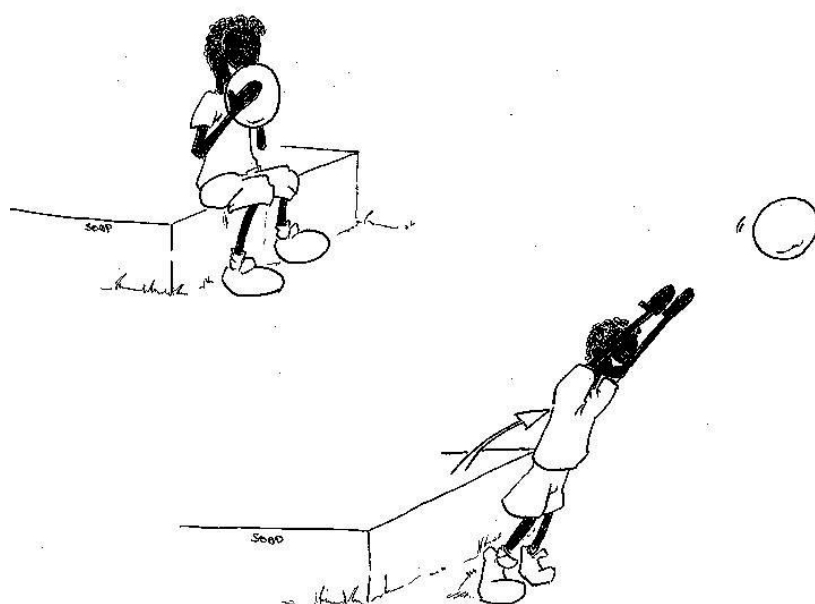

Instructions for the exercise:

- Throw after the legs' movement
- Lose balance forward

Noticeable points:

- Forward movement of the knees to position the pelvis
- Take-off with the legs
- Coordinate the action of the arms
- Keep the pelvis in a strong position generating strength

Teaching progression:

- Vary the starting height
- Vary the implements
- Vary the forms of throw

Safety:

- Appropriate Medicine ball
- Non-slippery ground
- Organisation of the group

Equipment:

- A Medicine ball
- Sitting equipment

Educational Card 4: Knee Throw

Objective: To try different forms of throw from the kneeling and sitting positions

Proposed situation: From the kneeling position, carry out throws of various appropriate objects. Throws are achieved from the left shoulder, then the right one, from the chest, from a rotational movement to the right and the left, of the outstretched arm (throwing objects of varying weight depending on the forms, but always 1kg maximum).

The beginner's behaviour: Beginners can not achieve any efficient throws because they do not use their thighs and pelvis to move the throwing object.

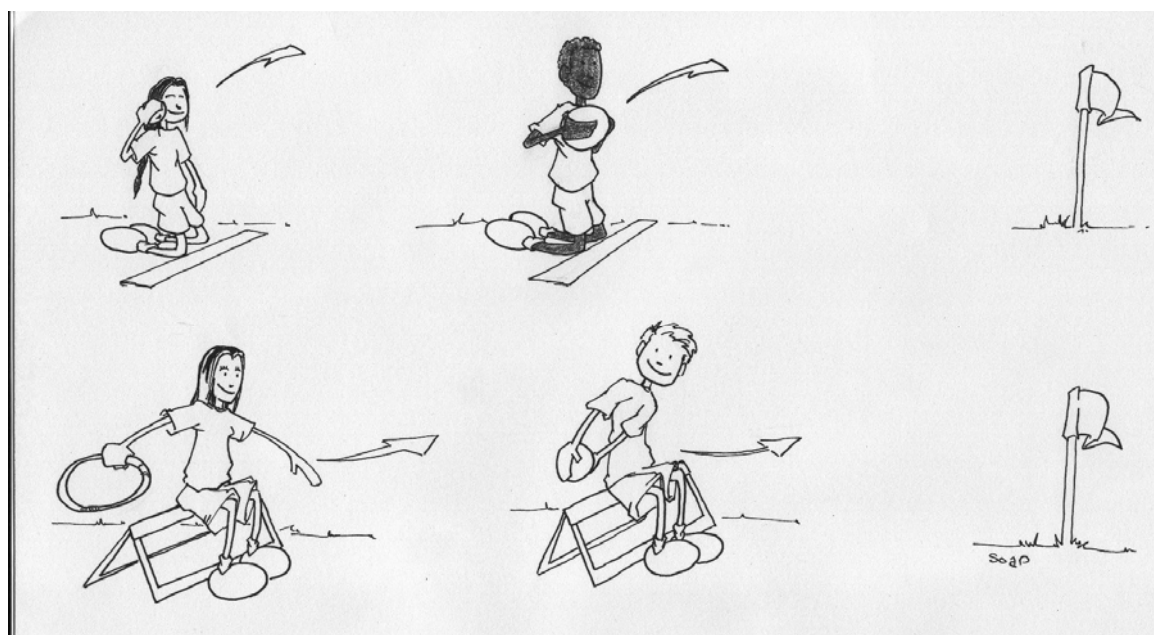

Instructions for the exercise:

- Block the pelvis
- Generate acceleration from a side backward position and move forward

Noticeable points:

- Do not collapse while throwing
- Lose balance forward after throwing
- Manage to throw upwards

Teaching progression:

- Change the throwing implements (forms, weight)
- Vary the grip of the objects
- Move towards games

Safety:

- Soft ground for the kneeling position
- Safe throwing objects

Equipment:

- Various implements
- A target

Educational Card 5: Knee Throw

Objective: To be able to command trajectories from a kneeling and sitting positions.

Proposed situation: From a kneeling or sitting position, throw similar or different objects towards targets placed at increasing distances. In the case of a rotational throw, shift the right-handed thrower slightly to the left of the targets (use various objects of 1kg maximum always).

The beginner's behaviour: Beginners do not remain in a steady position from one throw to another (Various collapses, backward movement of the shoulders, etc.). They find it difficult to be precise.

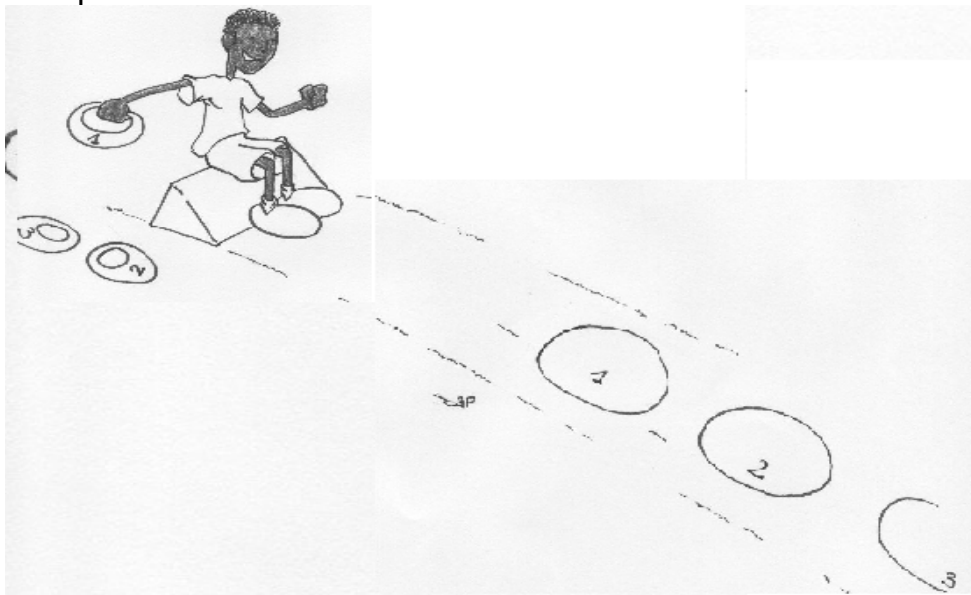

Instructions for the exercise:

- Remain in a strong position during the throw
- Look in the direction of the target
- Upon delivery, the shoulder/look faces the target

Noticeable points:

- Achieve the required exercises
- In the recovery phase, remain in a stable position or unbalanced in the direction of the throw
- Create sideways trajectories upwards

Teaching progression:

- Vary the implements and the grip
- Vary the distances
- Vary the order of targets

Safety:

- Safe implements
- Organisation of the group
- Priority is given to precision before distance

Equipment:

- Various implements
- Mats or seats
- Targets

EDUCATIONAL CARD: PRECISION THROW

Analysis of the situation: Throw a light implement at a target.
Master balance and control the leeway and intensity.

Safety of the participant: Selecting safe throwing implements and organising the group for throwing practice should be the best way to reduce the risks at the most.

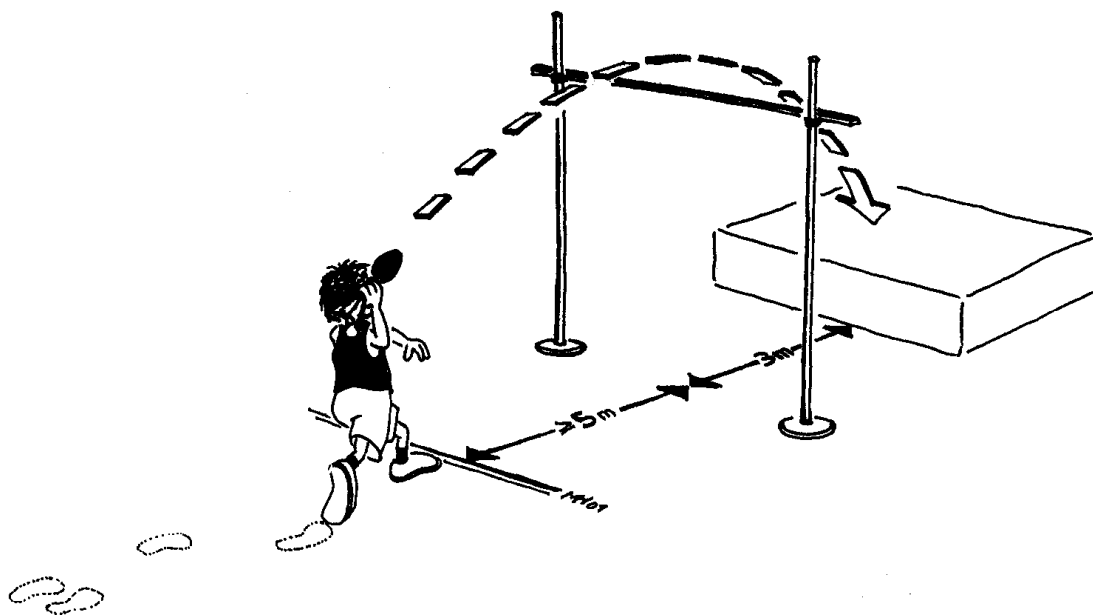

Event from IAAF Kids' Athletics Competition

Educational Card 1: Precision Throw

Objective: To improve the precision and the regularity of the throws

Proposed situation: To prepare the event, any target throwing practice will be beneficial. Varying and repeating the exercises will necessarily entail a progression.

The beginner's behaviour: Beginners will be clumsy because of the deformed movements of his/her body and because of a bad command of muscular tensions.

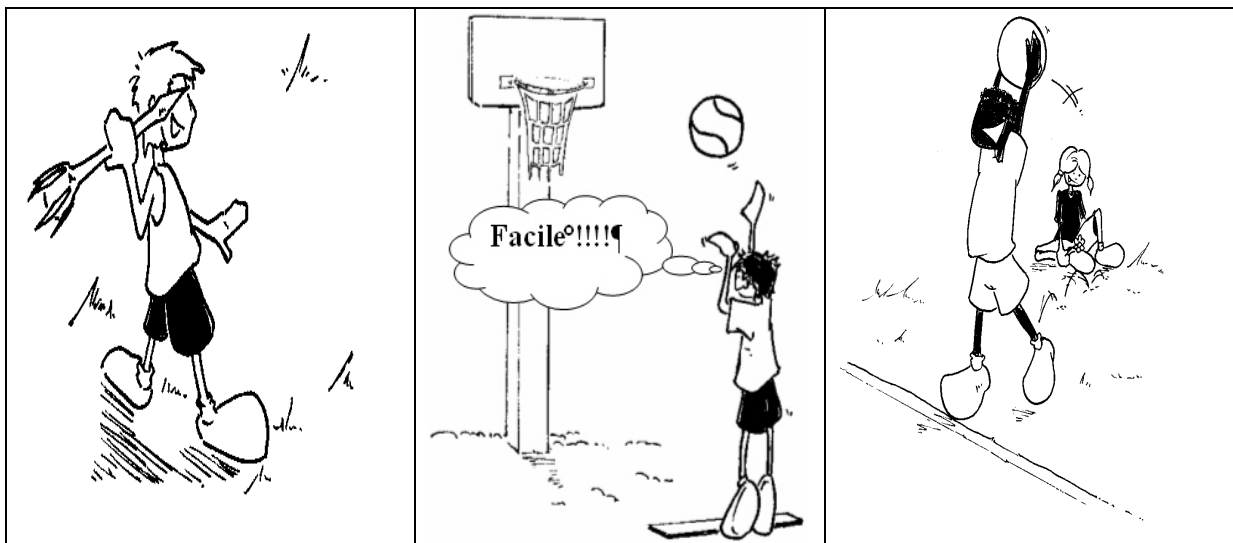

Instructions for the exercise:

- Check the sturdiness of the body
- Look at the achieved performance

Noticeable points:

- Precision in the throwing actions
- The body remains in straight position after delivery

Teaching progression:

- Various implements
- High, low, average targets
- Vary the implements in the throwing practice
- Vary the targets in the throwing practice
- Carry out increasing, decreasing or random throws
- Move towards games

Safety:

- Organisation of the group
- Safe throwing implements

Equipment:

- Various throwing implements
- Various targets

Educational Card 2: Precision Throw

Objective: To be able to throw various implements at various targets with precision

Proposed situation: Young athletes are offered to practice the target throw, with different throwing implements and numerous targets. The thrower will select the targets according to the implements at his/her disposal.

The beginner's behaviour: Beginners will be clumsy because of the deformed movements of his/her body and because of a bad command of muscular tensions.

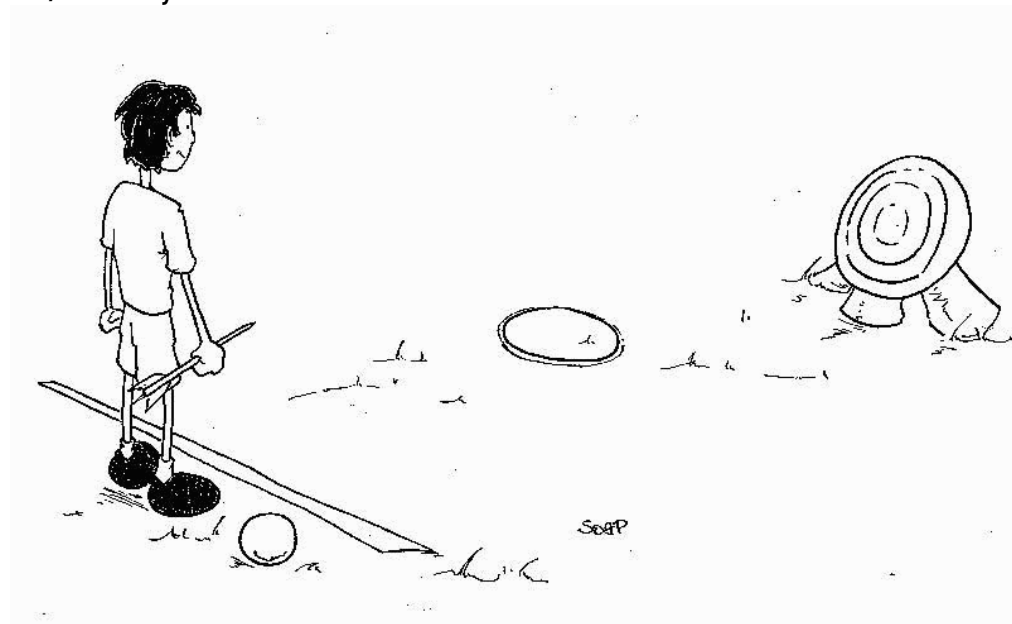

Instructions for the exercise:

- Check the sturdiness of the body
- Look at the achieved performance
- Select carefully the targets according to the retained implements

Noticeable points:

- Precision in the throwing actions
- upon delivery the body remains in line and in front of the target

Teaching progression:

- Various implements
- High, low, average targets
- Vary the implements in the throwing practice
- Vary the targets in the throwing practice
- Move towards games

Safety:

- Organisation of the group
- Safe throwing implements

Equipment:

- Various throwing implements
- Various targets

Educational Card 3: Precision Throw

Objective: To be able to throw similar implements at different targets

Proposed situation: The children have to carry out some throwing sequences of similar implements at compulsory targets, playing with various distances (+-, --, =+, etc.).

The beginner's behaviour: Beginners will be clumsy because of the deformed movements of his/her body and because of a bad command of muscular tensions.

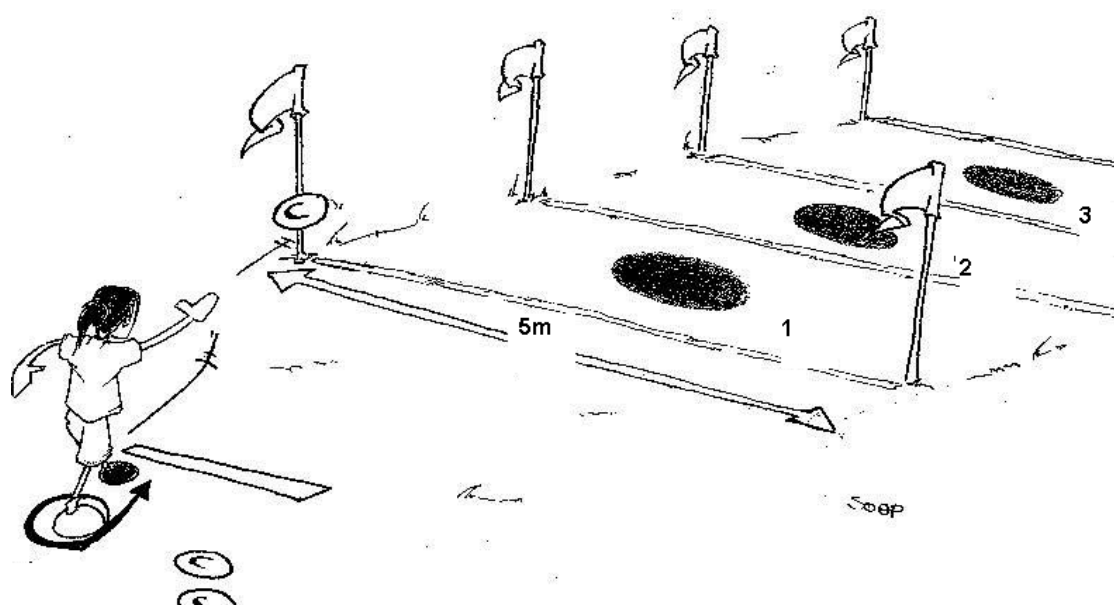

Instructions for the exercise:

- Respect the instructions for the targets
- Check the sturdiness of the body
- Look at the achieved performance

Noticeable points:

- Precision in the throwing actions
- The body is in line upon delivery

Teaching progression:

- Carry out increasing, decreasing or random throws (123, 321, 132, etc.)
- Move towards games

Safety:

- Organisation of the group
- Safe throwing implements

Equipment:

- Various throwing implements
- Various targets

Educational Card 4: Precision Throw

Objective: To improve the throwing precision from very stable positions

Proposed situation: From a sitting or kneeling position, beginners will have to throw various implements (different form, weight = 1kg maximum) at various targets.

The beginner's behaviour: Beginners will be clumsy because of the deformed movements of his/her body and because of a bad command of muscular tensions.



Instructions for the exercise:

- Check the sturdiness of the chest
- Look at the achieved performance

Noticeable points:

- Precision in the throwing actions
- The chest is facing the target upon delivery

Teaching progression:

- Various implements
- High, low, average targets
- Vary the implements in the throwing practice
- Vary the targets in the throwing practice
- Carry out increasing, decreasing, random throws
- For rotational throws, shift the right-handed thrower to the left of the targets (conversely for left-handed thrower)
- Move towards games

Safety:

- Organisation of the group
- Safe throwing implements
- A hurdle, a chair, a bench, etc.

Equipment:

- Various throwing implements
- Various targets

Educational Card 5: Precision Throw

Objective: Precision throws with walking strides

Proposed situation: After some walking strides beginners will have to throw various implements (different form, weight = 1kg maximum) from various positions at various targets.

The beginner's behaviour: Beginners will be clumsy because of the deformed movements of his/her body and because of a bad command of muscular tensions.

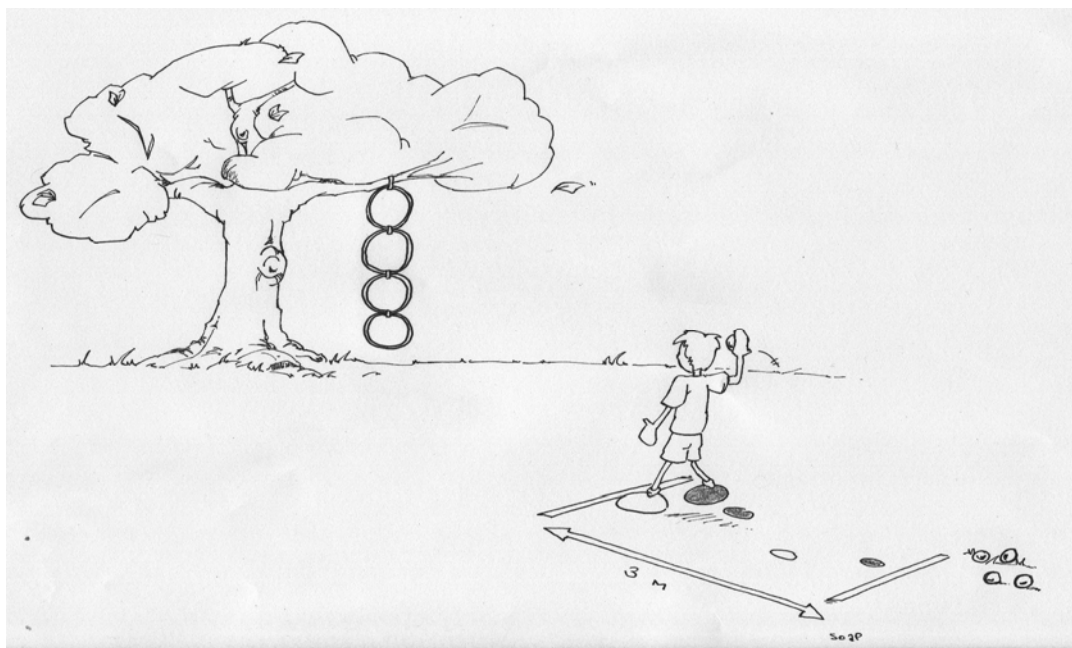

Instructions for the exercise:

- Master the balance upon delivery
- Look at the achieved performance

Noticeable points:

- Precision in the actions
- Balance in the delivery phase
- The chest/eyes are facing the target upon delivery

Teaching progression:

- Various implements, various distances
- Vary the implements in the throwing practice
- For rotational throws, shift the right-handed thrower to the left of the targets (conversely for left-handed thrower)
- Move towards games

Safety:

- Organisation of the group
- Safe throwing implements

Equipment:

- Various throwing implements
- Various targets

Educational Cards: Progressive endurance

Analysis of the situation: The proposed course emphasizes the speed control and the aerobic abilities of the participants. The event requires a saving strategy to be implemented at the beginning of the race.

Instructions for the safety of the participant: no danger on the proposed course, exhaustive explanation before the event takes place.

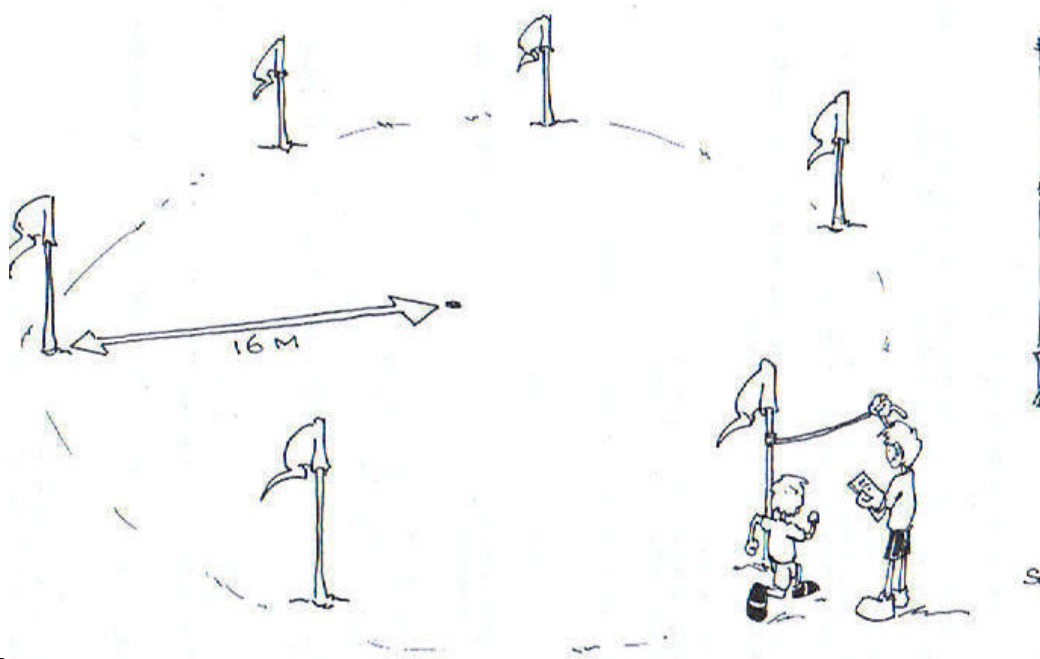

Figure

Opening gate: 5" according to the event planning

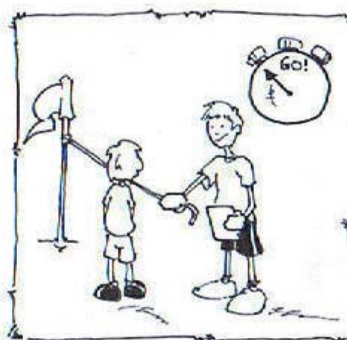

NB: These educational cards are also valid for the 1000m Endurance Event for the 11/12 years old, who will not have to follow any specific training programme.

Educational Card 1: Progressive endurance

Objective: To improve the command of the running speed

Proposed situation: Over relatively short distances (from 50 to 200m) the participants carry out “speed contracts”. Subtle mastery of the following notions: go faster, slower.

The beginner’s behaviour: Beginners have difficulty controlling the speed levels precisely. They often tend to run too fast or too slowly.

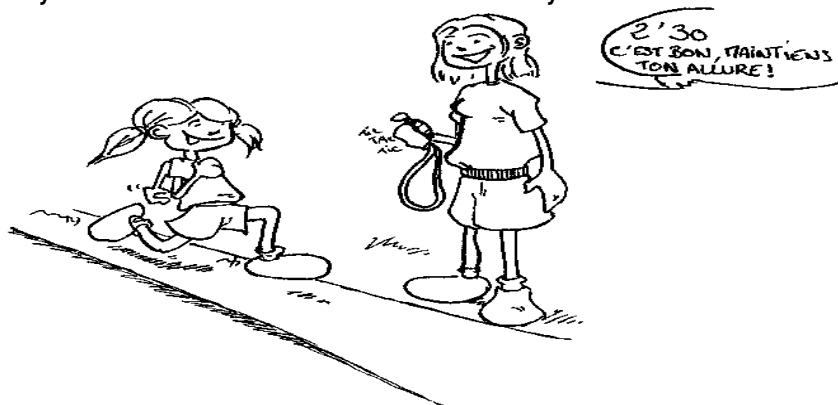

Instructions for this event:

- Breathe regularly
- Be very relaxed while running

Noticeable points:

- Respect the speed contracts
- Keep a regular stride
- Correct technical running
- Breathing control

Teaching progression:

- Vary the distances and the speed levels
- In a given time, complete various distances on close areas (the lanes of a track for example)
- Run around different courses (with banks, etc.)
- Move towards games

Safety:

- Heart controlling
- Appropriate speed and recovery

Equipment:

- Stopwatches
- Markers
- A measuring tape

Educational Card 2: Progressive endurance

Objective: To control a sequence of various speed levels

Proposed situation: Have the children link up stretches of distance at specific and various paces. To facilitate the organisation, it is better to complete various distances in a given unchanging time (ex.: run together 40m in 15", and 30m in 15" over a rectangular course).

The beginner's behaviour: Beginners have difficulty controlling their pace throughout the distance. They often wait for the starting signal at the level of the plot, to start running again. These changes of pace are often too abrupt and with a high cost in energy.

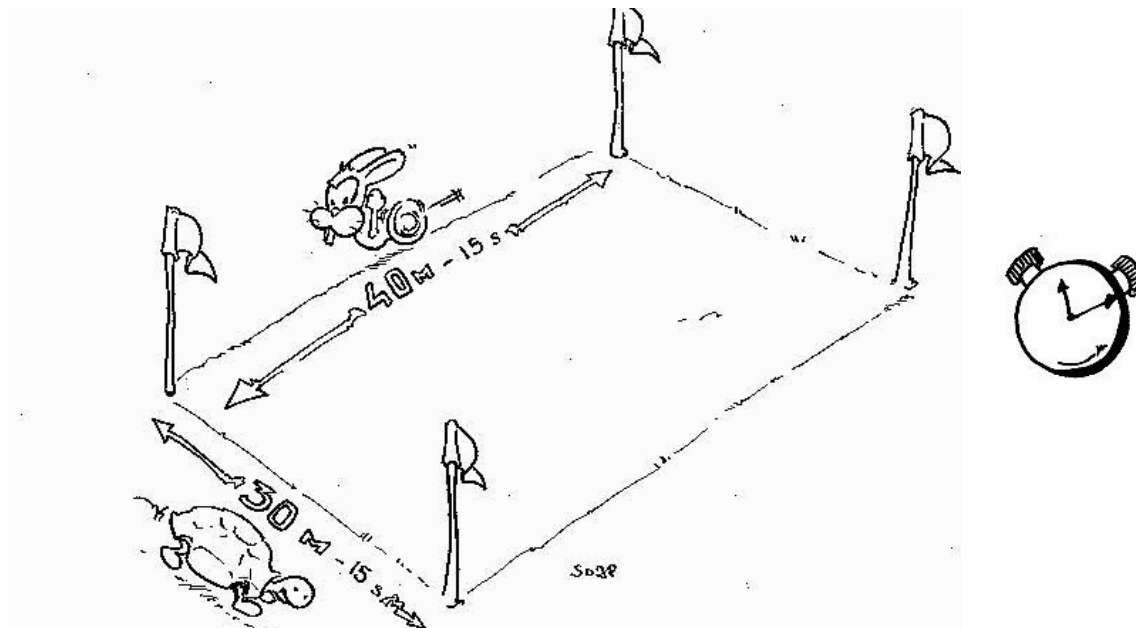

Instructions for the exercise:

- Achieve progressive changes of pace
- Be relaxed while running

Noticeable points:

- Command the speed contracts
- Keep breathing easily
- Search for energy saving

Teaching progression:

- Vary the paces and the running distances
- Complete progressive and decreasing sequences, etc.
- Move towards games (experiment: at what pace will they run?)

Safety:

- Safe courses
- Appropriate pace

Equipment:

- Vertical markers
- a stopwatch / a whistle

Educational Card 3: Progressive endurance

Objective: To improve one's aerobic abilities

Proposed situation: According to the scores obtained to the preceding event, run stretches of distance in 1' to 3', at a speed equivalent (or close) to the speed recorded for the 6m test. Always provide moments for recovery at least as long as the duration of the race, even once and a half the duration of the race for more safety.

The beginner's behaviour: Beginners have difficulty running regularly at a pace different from their own individual pace.

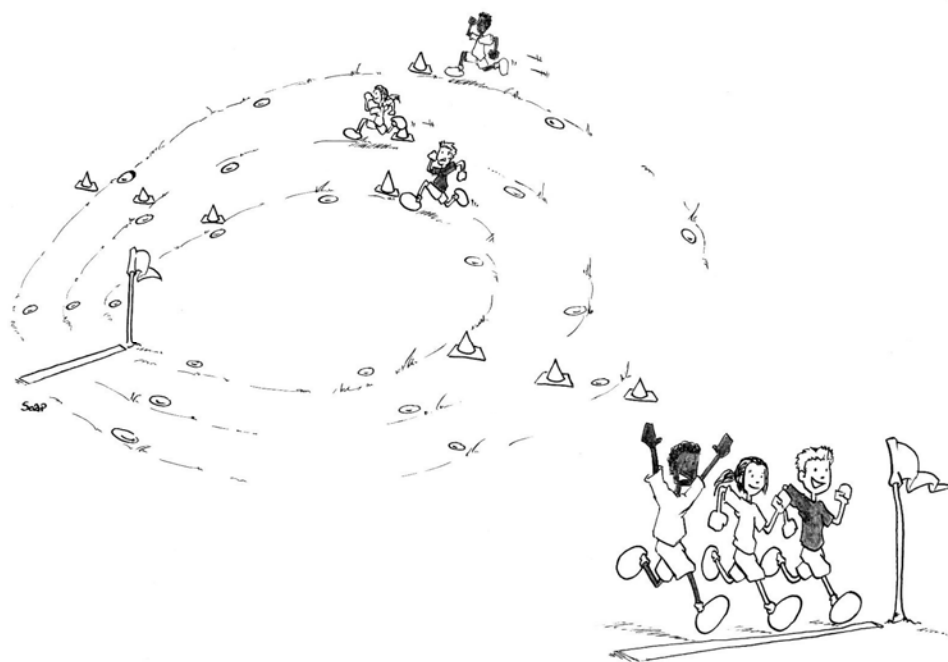

Instructions for the exercise:

- Keep breathing under control
- Run in a regular and relaxed way

Noticeable points:

- Respect the contract
- Maintain a good technical running
- Restart the running sequence with a minimum recovery (easy breathing)

Teaching progression:

- Vary the running sequences
- Measure the pulse rate during recovery phases
- Run on various areas
- Move towards games

Safety:

- Appropriate pace and recovery
- Heart controlling

Equipment:

- Markers, a measuring tape
- Stopwatches

Educational Card 4: Progressive endurance

Objective: To control one's pace on various tracks and distances

Proposed situation: Provide the athlete with various courses (banks, climbing and descending slopes, etc.), on which he/she will have to control his/her speed (faster, slower, etc.).

The beginner's behaviour: Face to varying landmarks, beginners will have difficulty controlling the following notions "go faster"/"slower". Their reaction will often be to go from one extreme to the other (much slower, much faster).

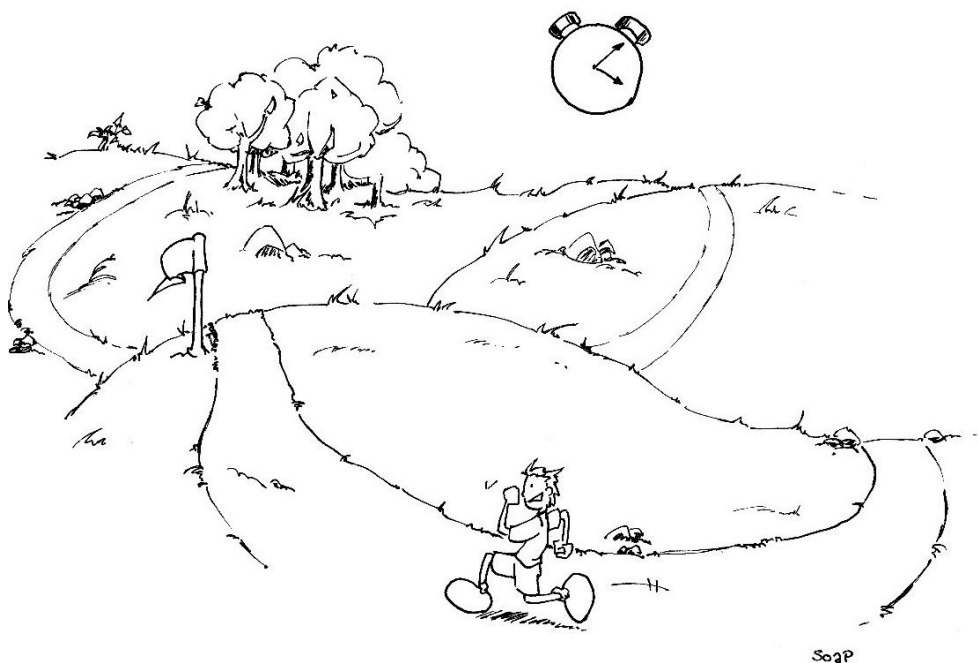

Instructions for this event:

- Feel deeply one's own pace
- Listen to one's breathing
- Run as regularly as possible in spite of the varying nature of the course

Noticeable points:

- Respect of the contracts
- Easy breathing
- Smooth course in terms of pace

Teaching progression:

- Vary the courses
- Move towards games (relay, etc.)

Safety:

- Safe course
- Appropriate race's programme

Equipment:

- Vertical markers
- A stopwatch / a gate rope

Educational Card 5: Progressive endurance

Objective: To master the endurance race event

Proposed situation: In the form of a meeting in terms of organisation, the athlete will be confronted to a varied range of running programmes.

The beginner's behaviour: Beginners often have difficulty controlling their pace with precision. They often arrive too early at the gate, and therefore mortgage their result for the event.

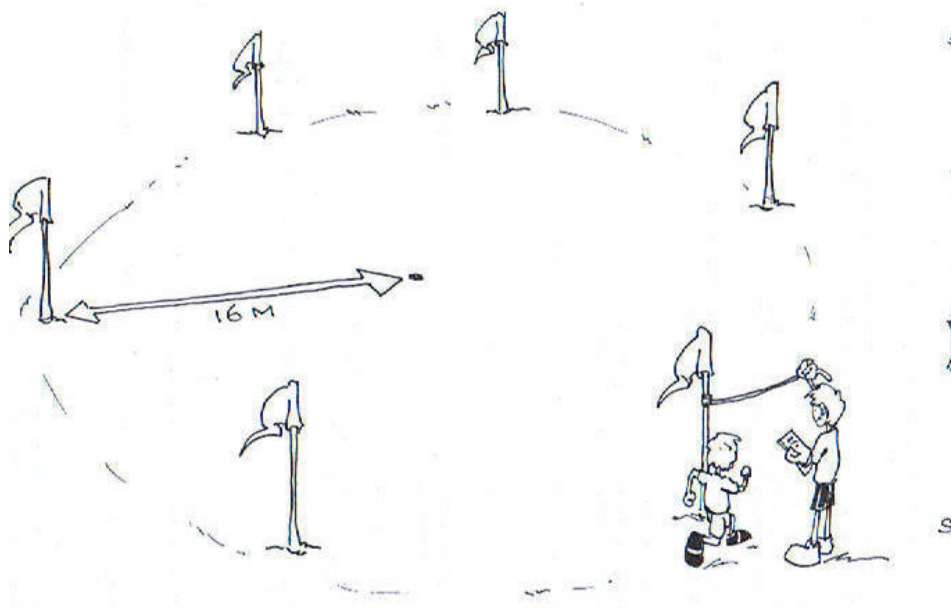

Instructions for the exercise:

- Run regularly to save energy
- Breathing regularly
- Assimilate the programme of the race (faster, much faster, etc.)

Noticeable points:

- Arrivals adjusted to the opening gate
- Easy breathing
- Regular pace

Teaching progression:

- Diversity of programmes
- Progression towards games

Safety:

- Safe course
- Appropriate running programme

Equipment:

- Vertical markers
- A stopwatch / a gate rope

EDUCATIONAL CARD: SPRINT/HURDLES SLALOM SHUTTLE RELAY

Analysis of the situation: This sprinting event requires:

- The adjustments to the flat and the slalom/hurdles distances
- The mastery of clearance actions on both sides
- The mastery of the upper free segments

Safety of the participants: Selecting the hurdles and a soft ground will solve most of the safety problems. Practicing and training is the key to safety too.

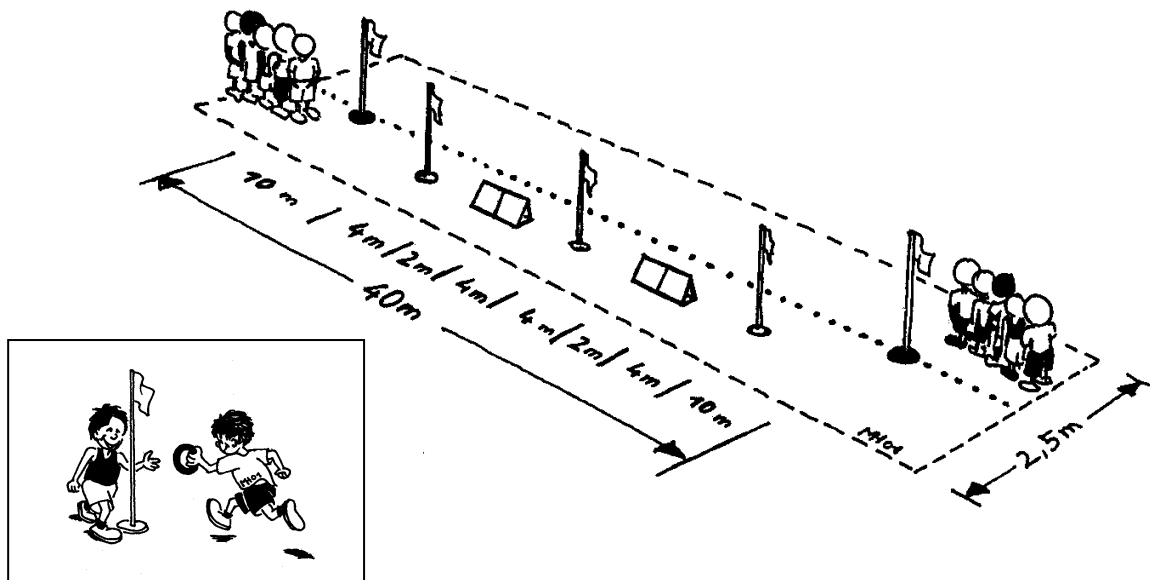

Event from IAAF Kids' Athletics Competition

Educational Card 1: Sprint/Hurdles Slalom Shuttle Relay

Objective: To improve the mastery of clearance

Proposed situation: Over a course following an oblique trajectory, the participants stride across low obstacles from one side to the other (right and left) with an even number of intermediary strides.

The beginner's behaviour: Beginners will extend the lead leg forwards. Landing after clearance is carried out in a safe position (two feet touchdown).

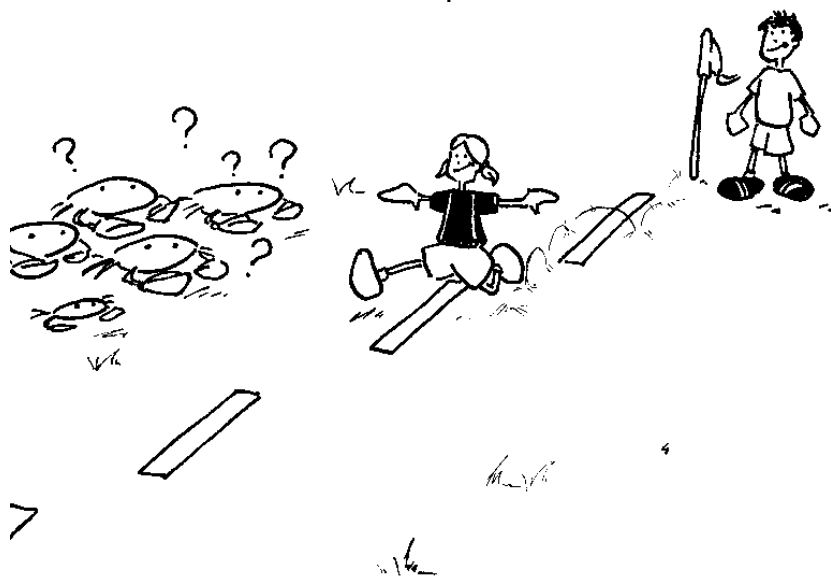

Instructions for the exercise:

- Run as naturally as possible
- Do not use your arms for balance

Noticeable points:

- Link up Sprint/Clearance
- Correct performance on both sides
- Correct use of the free segments (close to the sprinting technique)
- Immediate running action after clearance

Teaching progression:

- Experiment a 2-stride regular rhythm on both sides
- Practice the exercise in a standing upright position
- Practice high jumping (hurdles), forward jumping (water)
- Experiment the exercise with irregular intervals between hurdles (increasing, decreasing, at random)
- Evolution towards individual games and collective games

Safety:

- Non-slippery ground
- Safe markers
- Organisation of the group

Equipment:

- Vertical markers along the course
- Horizontal markers

Educational Card 2: Sprint/Hurdles Slalom Shuttle Relay

Objective: The mastery of the slalom technique

Proposed situation: Slaloming sprint in a varying course imposing the participants to carry out a sequence of slaloms with different or regular radius.

The beginner's behaviour: Facing the left direction and the right direction, beginners achieve the slaloming exercise. They often modify their pace to be able to slalom (double support, etc.).

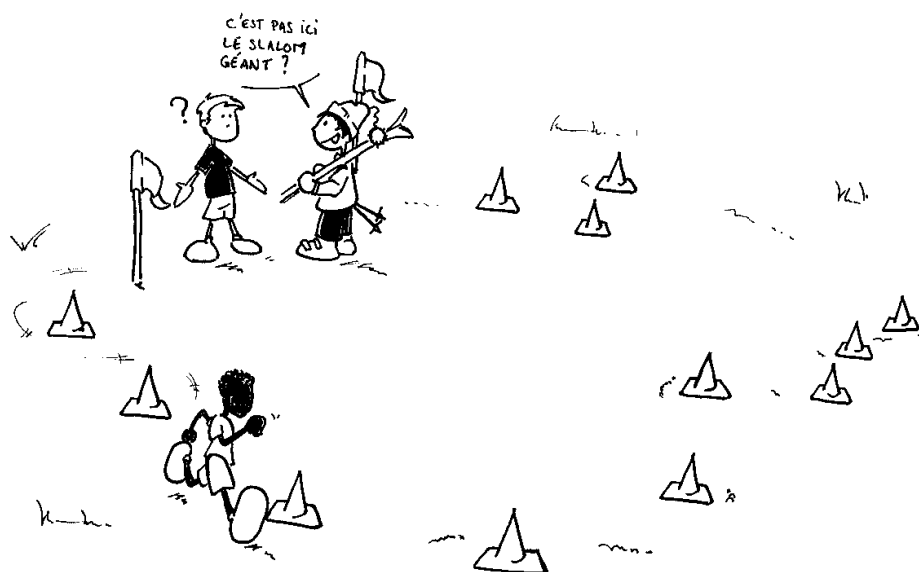

Instructions for

the exercise:

- Face the running direction
- Do not modify your pace

Noticeable points:

- Maintain the running speed and face the running direction
- Play with angles between the body and the right and left directions
- Maintain the driving action of the arms (not balancing action)

Teaching progression:

- Experiment the symmetrical slaloming
- Practice the slaloming to the right and to the left
- Experiment the courses in ellipse, in figure of eight, in circle, etc.
- Practice sideways runs (to the right and the left, even backwards)
- Evolution towards games

Safety:

- Non-slippery ground
- Safe markers

Equipment:

- Vertical markers

Educational Card 3: Sprint/Hurdles Slalom Shuttle Relay

Objective: To improve the baton handling

Proposed situation: Changeover sequences with various implements in a static or dynamic position.

The beginner's behaviour: Beginners look at the baton to ensure a good changeover and often slow down (or stop) for exchange.

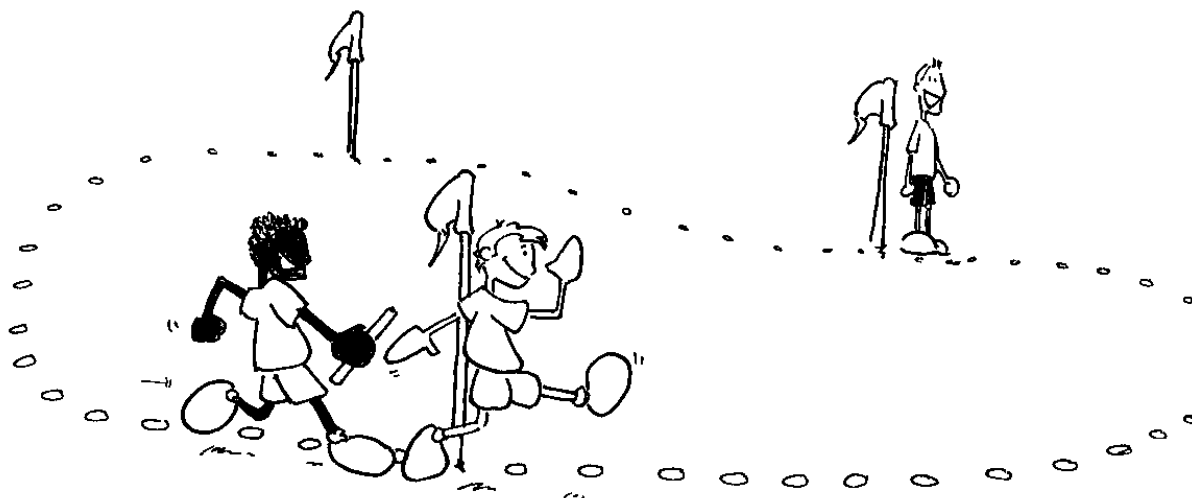

Instructions for the exercise:

- Select carefully the receiving arm
- Talk to your partner

Noticeable points:

- Do not let the implements drop
- No loss of speed during the changeover
- Mastery of the exchange (giving and receiving actions) with both hands
- Minimum disruption in the cyclic movement of the arms for the changeover

Teaching progression:

- Variety of the implements (small, big, long, round, etc.)
- Experiment the dynamic position of the incoming runner and the outgoing runner, then both
- Practice the placement of the right hand and the left hand in the two positions
- Evolution towards games (various forms of relays)

Safety:

- Organisation of the group
- Safe batons

Equipment:

- Various batons
- Vertical markers

Educational Card 4: Sprint/Hurdles Slalom Shuttle Relay

Objective: To master side hurdles clearance with the right leg and the left leg

Proposed situation: Propose the participants to practice a sequence of side hurdles clearance from the right and the left sides with a 3-stride rhythm between hurdles.

The beginner's behaviour: Beginners will first clear all hurdles from the same take-off leg. Then they will have difficulty proceeding to running after clearance from both sides. They tend to be too far from the running direction.

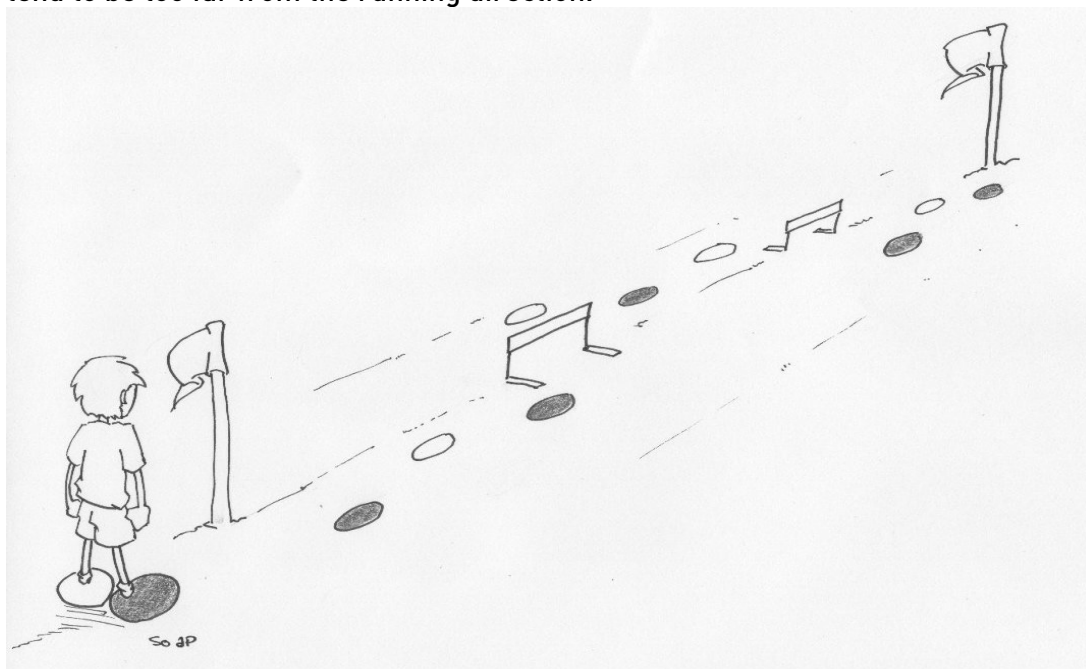

Instructions for the exercise:

- Take-off as close as possible to the running direction
- Proceed to running directly after clearance

Noticeable points:

- Carry out the hurdles clearance from both sides
- Keep a running speed as often as possible
- A stopwatch

Teaching progression:

- Vary the hurdles height
- Vary the intervals between hurdles (proceed to 5 in-between strides)
- Keep the time
- Evolution towards games

Safety:

- Safe hurdles
- Organisation of the group
- Appropriate space for practice

Equipment:

- Hurdles
- Vertical markers
- Stopwatches

Educational Card 5: Sprint/Hurdles Slalom Shuttle Relay

Objective: To master the competition's event

Proposed situation: The event from the IAAF Kids' Athletics Competition is presented.

The beginner's behaviour: Beginners have problems selecting a starting point between the flat and the slalom/hurdles legs. The gates or flag poles represent additional difficulties because they focus on the obstacles.

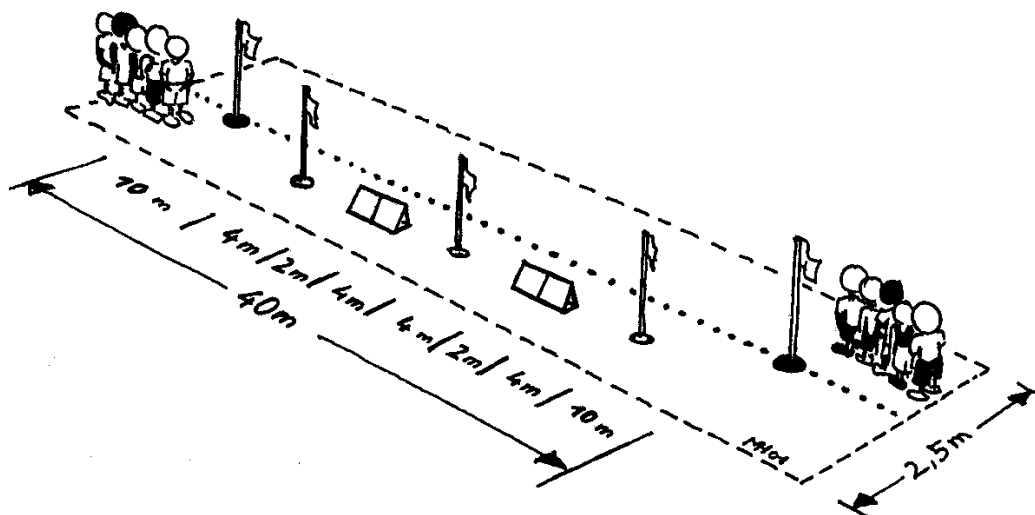

Instructions for the exercise:

- Comply with all the requirements of the course
- Run as close as possible to the running direction

Noticeable points:

- Achievement of the exercise
- Regular running speed
- General balance throughout the course

Teaching progression:

- Start from the left side then the right side of the course (as indicated by a cone)
- Relays, duel formula, etc.

Safety:

- Well-organised course
- Organised group

Equipment:

- Hurdles
- Vertical markers
- A stopwatch

EDUCATIONAL CARD : POLE VAULT

Analysis of the event: The pole vault event requires several abilities: to master the carry of the pole, to master a balanced take-off from the pole, planting it downwards and forcing it into the ground to carry oneself in the direction of a target object.

Safety of the participants: For “in-competition” event, safety will be guaranteed by a good jumping practice, a selected soft ground for landing and a suitable pole for children.

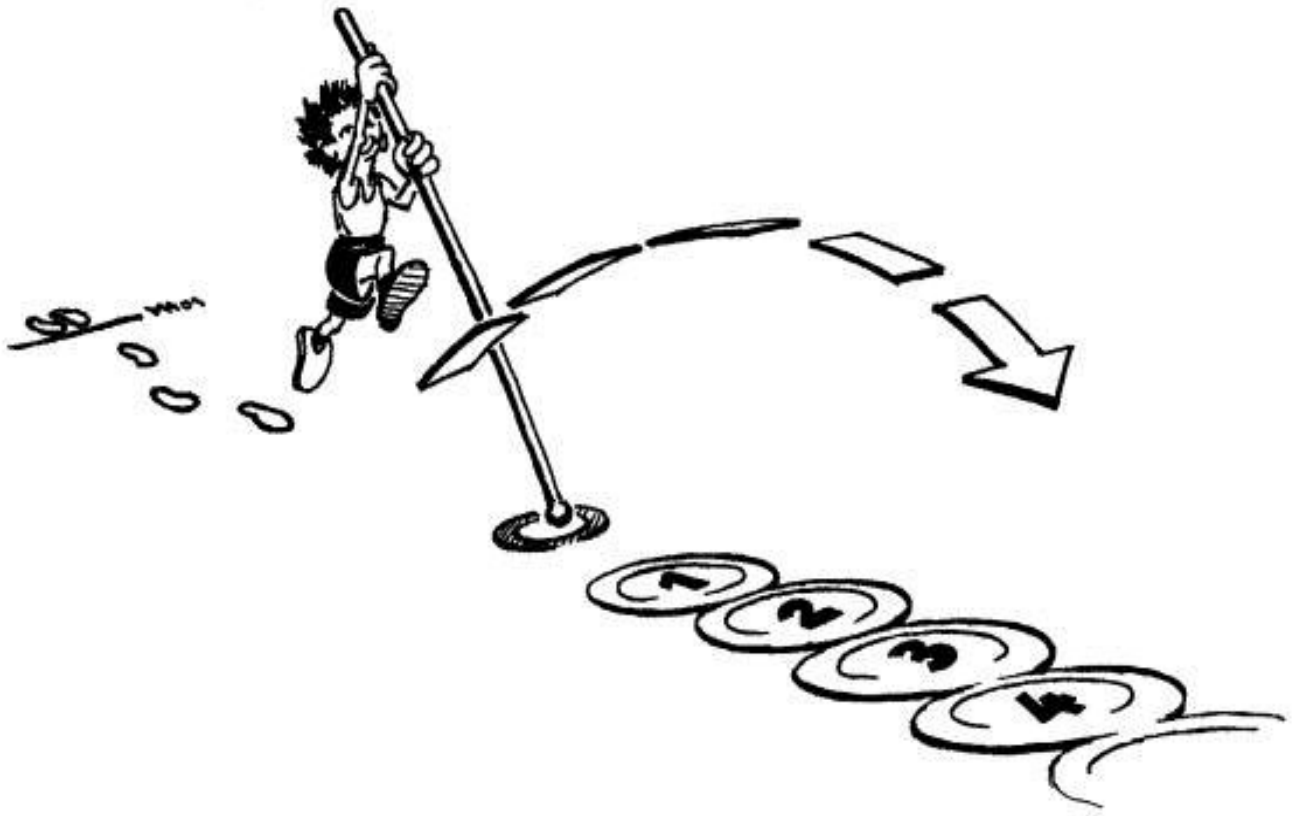

Event from the IAAF Kids' Athletics Competition

Educational Card 1: Pole Vault

Objective: To master the hanging and the landing phase

Proposed situation: Starting from a stable and appropriate platform, the athletes have to carry out a jump, taking off from the pole and control the landing on both feet.

The beginner's behaviour: Beginners often jump without taking off from the pole; they do not push the pole forwards and often let it drop during the action.

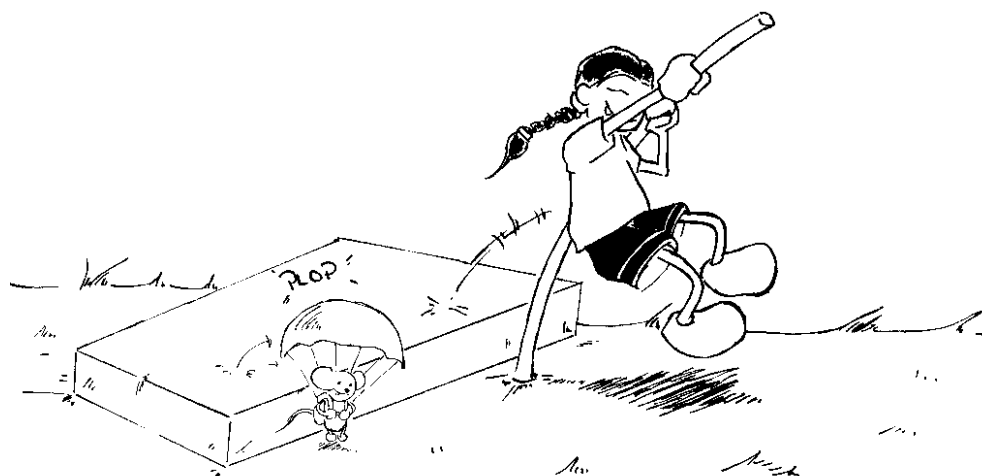

Instructions for the exercise:

- Do not release the pole
- Push the pole forwards
- Cushioned landing

Noticeable points:

- Balanced front landing on both feet in the jumping direction
- Take-off from the pole and push it forwards
- No release of the pole

Teaching progression:

- Vary the height of the platform (always appropriately)
- Vary the landing area
- Change slightly the grip height
- Every exercises should turn into games

Safety:

- Soft landing area
- Appropriate height platform

Equipment:

- Short poles
- Stable platform

Educational Card 2: Pole Vault

Objective: To master the take-off from the pole

Proposed situation: The participants jump over a stable platform from a ground take-off and with the drive of the pole.

The beginner's behaviour: Beginners often tend not to use the pole to jump over the platform. They try to jump directly from the ground, without taking-off from the pole.



Instructions for the exercise:

- Do not release the pole
- Push the pole forwards
- Lift up your feet to land on the platform

Noticeable points for a successful jump:

- Balanced front landing on both feet in the jumping direction
- Ground take-off and forward push of the pole
- No release of the pole

Teaching progression:

- Heighten the platform
- Vary the landing positions on the platform
- Link "get in and get off the platform"
- Move towards games

Safety:

- Stable and appropriate platform
- Short pole

Equipment:

- Appropriate platform height
- Appropriate pole

Educational Card 3: Pole Vault

Objective: To master the carry of the pole and the take-off from the pole

Proposed situation: Carry the pole with walking steps then proceed to a stride from the pole drive. Again take walking steps, and then stride from the pole drive, and so on.

The beginner's behaviour: Beginners do not hang on the pole but shift from the axis of the pole and do not push it forwards.

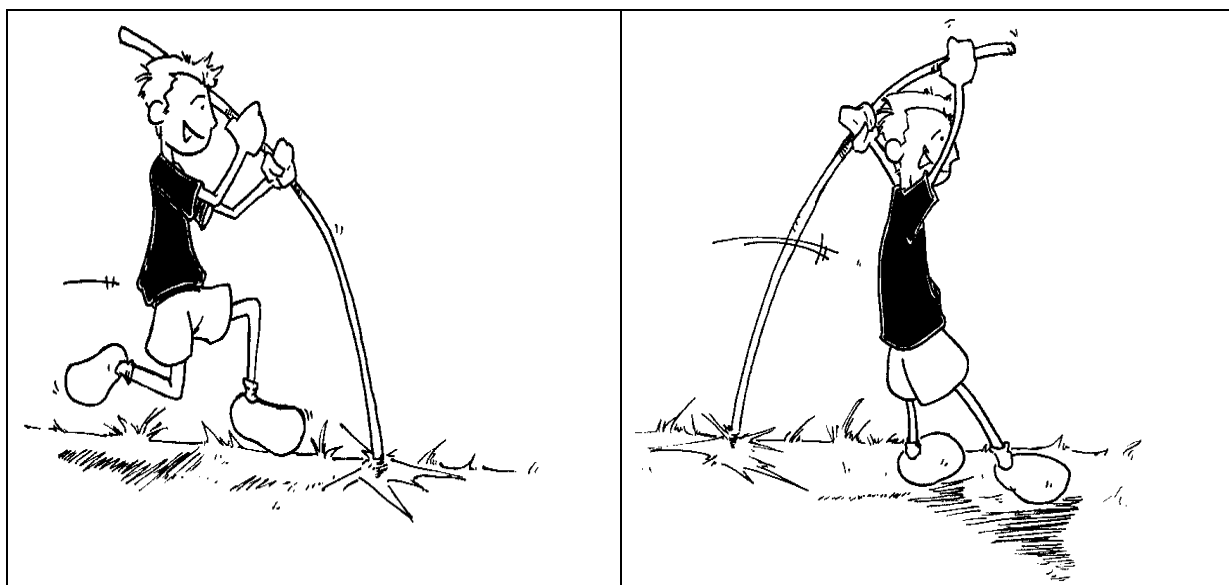

Instructions for the exercise:

- Remain in a balanced position
- Cushion the landing
- Do not release the pole

Noticeable points:

- Land from the balancing flight and start walking again
- Proceed to the take-off from/hanging on the pole phase
- Link easily repeated walking sequences

Teaching progression:

- Practice on the right and the left side
- Walk giant steps with the pole
- Proceed from walking pace to slow running speed
- Direct the practice to playing activities

Safety:

- Soft and non-slippery ground

Equipment:

- Appropriate poles

Educational Card 4: Pole Vault

Objective: To improve the approach run with the pole.

Proposed situation: Achieve a whole series of approach runs with the pole.

The beginner's behaviour: Beginners do not manage to “isolate” the running action from the carrying of the pole. The pole has unrestrained movements during the run.

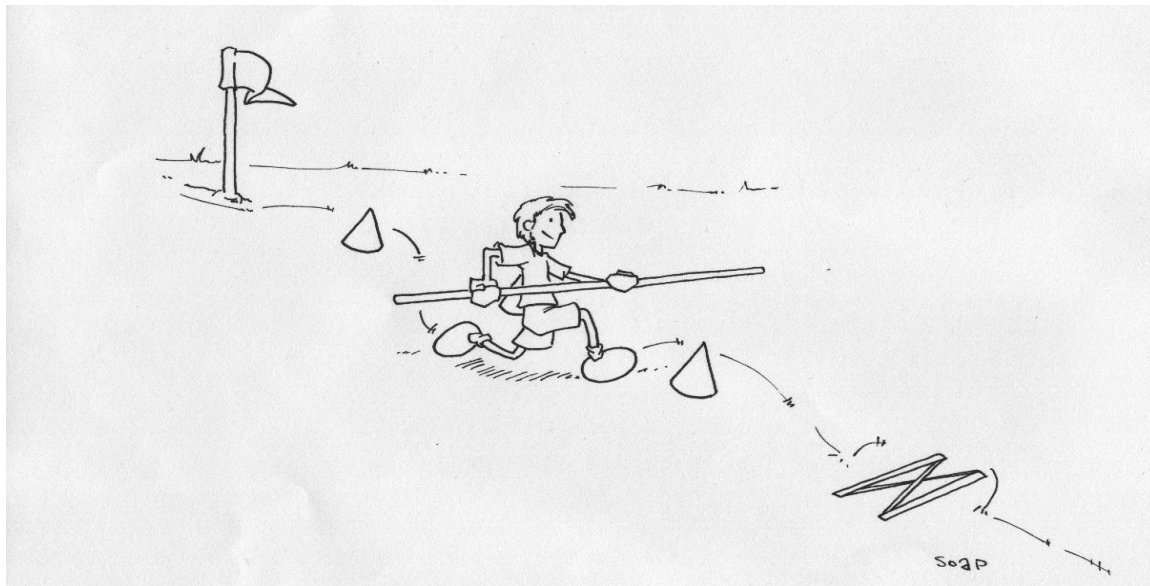

Instructions for the exercise:

- Run with relaxed shoulders
- Hold the pole in the running direction

Noticeable points:

- The pole is maintained in the running direction in a stable position
- Complete a proper run

Teaching progression:

- Present as many exercises as possible
- Increase the speed
- Move towards games

Safety:

- Organise the group
- Appropriate poles

Equipment:

- Poles
- Vertical markers
- Horizontal markers

Educational Card 5: Pole Vault

Objective: To practice the Tuck over the bar

Proposed situation: Hanging on a rope (or a chinning bar), the participants have to lift up their lower limbs to get them over their head.

The beginner's behaviour: Beginners have great difficulty performing this exercise because they are weak on their muscular drives and feel clumsy in this unusual position (their legs are shifted from the rope axis).

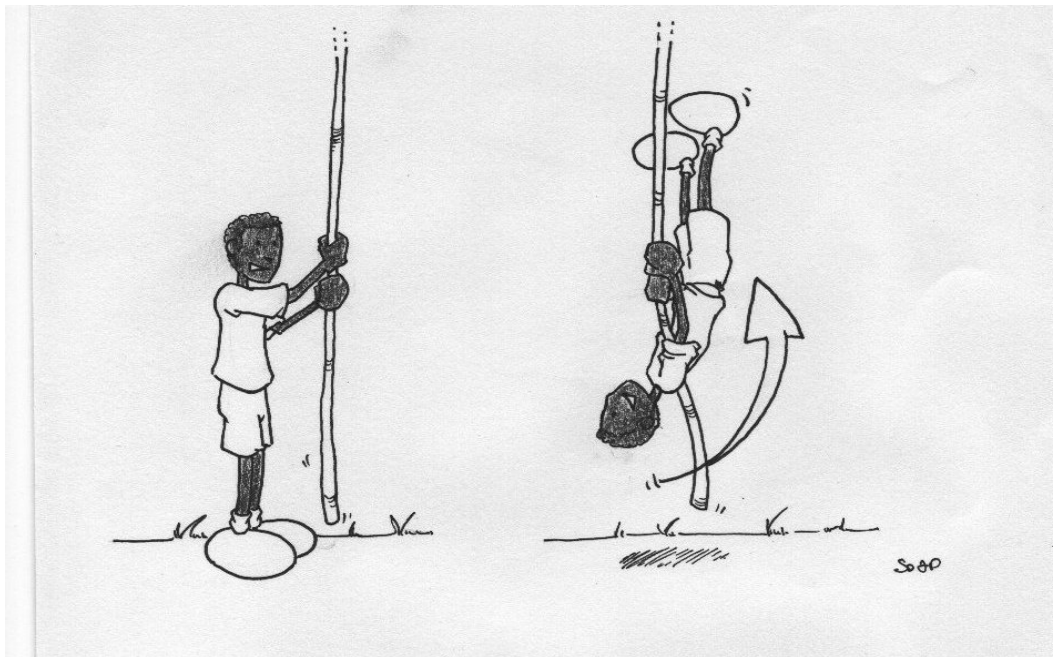

Instructions for the exercise:

- Tuck your legs near your body
- The feet cling to the rope to get them as high as possible
- Never let your hands go

Noticeable points:

- The pole leaves the running direction and is not stable (unrestrained up and down movements and side movements)
- Low-quality approach (the hips are low, the feet are laid flat)

Teaching progression:

- Swing the rope when their feet are hanging on the rope
- Without rockback turning, keep the feet tucked during the swinging movements of the rope
- Move towards games

Safety:

- Check the level of the children
- Soft ground or mats

Equipment:

- A rope
- Mats

EDUCATIONAL CARD: ROTATIONAL THROW

Analysis of the throwing practice: With a rotational movement, throw a light implement towards a precise target. This action implies:

- experimenting the rotational throw (axis, radius, strides)
- mastering balance

Safety of the participants: The rotational throw is a high-risk throw. Selecting safe implements, organising the throwing area (markers, targets), organising the group for throwing practice (left-handed throwers on the left, sufficient room, throw in turn) and the action timing (throw, pick up the implements) should be enough to reduce the risks at the most.

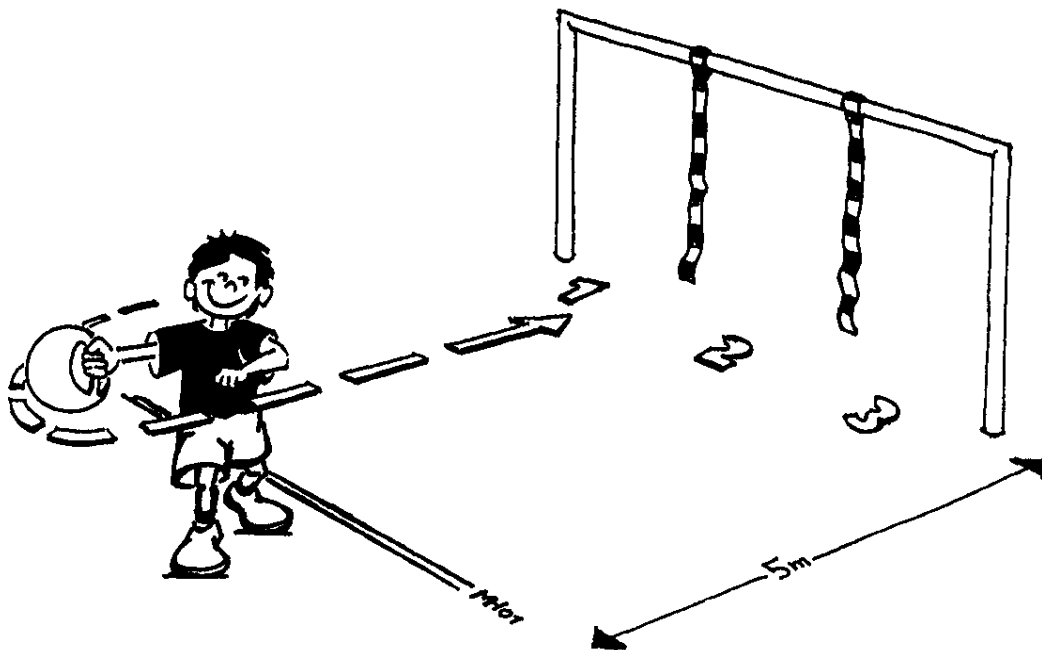

Event from IAAF Kids' Athletics Competition

Educational Card 1: Rotational Throw

Objective: To experiment the rotational throwing action

Proposed situation: Experiment the action of the upper half of the body with light implements easy to handle (hoops, clubs, etc.) with a maximum weight of 1kg.

The beginner's behaviour: Beginners will perform a rotational throw and pull the implement from the opposite side. Right-handed throwers will move their left shoulder back.



Instructions for the exercise:

- Remain in front of the target
- Keep looking at the target
- Hold the implement away from the body to throw it

Noticeable points:

- Throw in the throwing direction / Delivery in a forward front position
- The other arm (not throwing) does not collapse
- No backward movement from the side opposite to the throwing arm
- Keep balance after the delivery

Teaching progression:

- Move the target back
- Throw at targets placed at progressive or random distances
- Throw with various implements
- Move towards games

Safety:

- Select safe throwing implements
- Strict instructions for the organization of the group

Equipment:

- Various throwing implements
- Clearly visible targets

Educational Card 2: Rotational Throw

Objective: To approach the rotational throw with a forward front movement

Proposed situation: Experiment the rotation. Use handy implements (as in the first exercise). Shift the feet on both sides of the ideal throwing axis. Face the right side of the throwing direction and forward in the throwing direction.

The beginner's behaviour: Beginners will carry out throws with a forward movement of their shoulders, forgetting about their hips in the starting position.

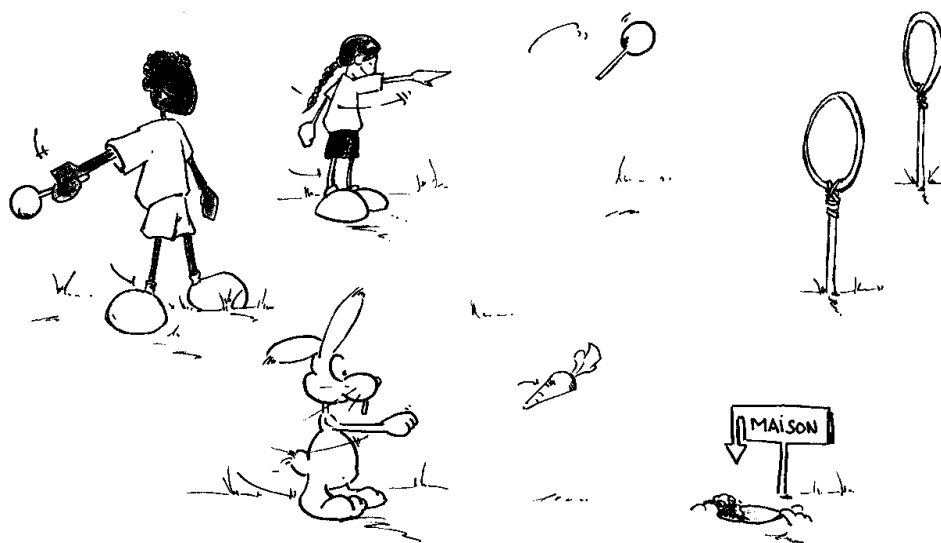

Instructions for the exercise:

- Keep facing the direction of the throw, the eyes looking at the target upon delivery
- Precision comes before strength
- Be careful about the other participants

Noticeable points:

- Throw in the throwing direction / Delivery in a forward front position
- The other arm (not throwing) does not collapse
- No backward movement from the side opposite to the throwing arm
- Activity of the rear foot to impart the action

Teaching progression:

- Move the target back
- Throw at targets placed at progressive or random distances
- Throw with various implements
- Amplify the rotational action with back facing the throwing direction
- Move towards games

Safety:

- Select safe throwing implements
- Strict instructions for the organisation of the group

Equipment:

- Various throwing implements
- Clearly visible targets

Educational Card 3: Rotational Throw

Objective: To discover the support in the rotational throw

Proposed situation: Experiment the rotational walk. Children have to walk along a line in a rotational movement: 1 foot at 45°, 90° up to 180°.

The beginner's behaviour: Beginners have difficulty shifting the body weight to the heel or the sole of the foot. When they shift to the heel, they move the hips backwards.

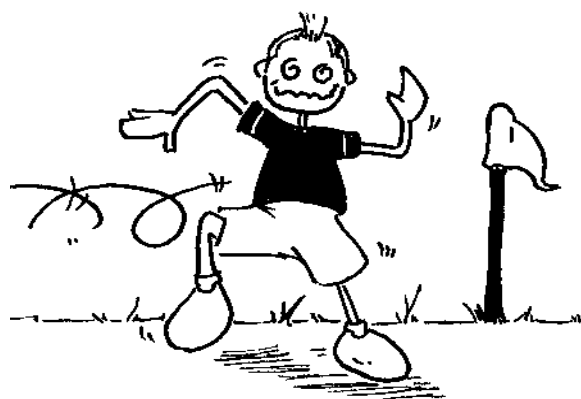

Instructions for the exercise:

- Activate the feet
- Do not look at the feet

Noticeable points:

- General balance
- Provide the rotation with the support action
- Move along a straight line

Teaching progression:

- Walking in a standing or bent position
- Achieve the walking exercise with a left then right rotation
- Carry out a throw at the end of the rotational walk
- Move towards games

Safety:

- A ground appropriate for rotations
- Flat ground without holes

Equipment:

- Markers
- Foul lines, chalk lines

Educational Card 4: Rotational Throw

Objective: To improve acceleration of an object with a rotational throw

Proposed situation: Starting with the back facing the direction of the throw, one throws a medicine-ball over one's shoulder (right then left shoulder), the whole body being put to work (maximum weight of the throwing implements: 2kg).

The beginner's behaviour: Beginners will stay with the back facing the throwing area. He/she will often lose balance backwards after throwing.



Instructions for the exercise:

- Command the throwing implement with legs
- Right and left rotations (for right-handed throwers) of the body to carry out the throw

Noticeable points:

- Balanced body in the delivery phase
- Body facing the left side while throwing over the left shoulder (and vice versa)
- Arms stretched upwards obliquely in the delivery phase

Progression of the situation:

- Vary the implements (weight, form)
- Vary the compulsory distances
- Throw from the right and the left sides
- Move towards games

Safety:

- Organisation of the group
- Priority is given to the direction of the throw

Equipment:

- Various implements
- Vertical markers

Educational Card 5: Rotational Throw

Objective: To master a rotational throw for precision after taking walking strides

Proposed situation: To propose throwing with a rotation at a target after taking walking steps with Left Right Left foot for right-handed throwers (maximum weight of the implements: 1kg).

The beginner's behaviour: The walking strides will entail unsteady movements and the throwing implement will often be placed before the thrower in the final phase of acceleration.

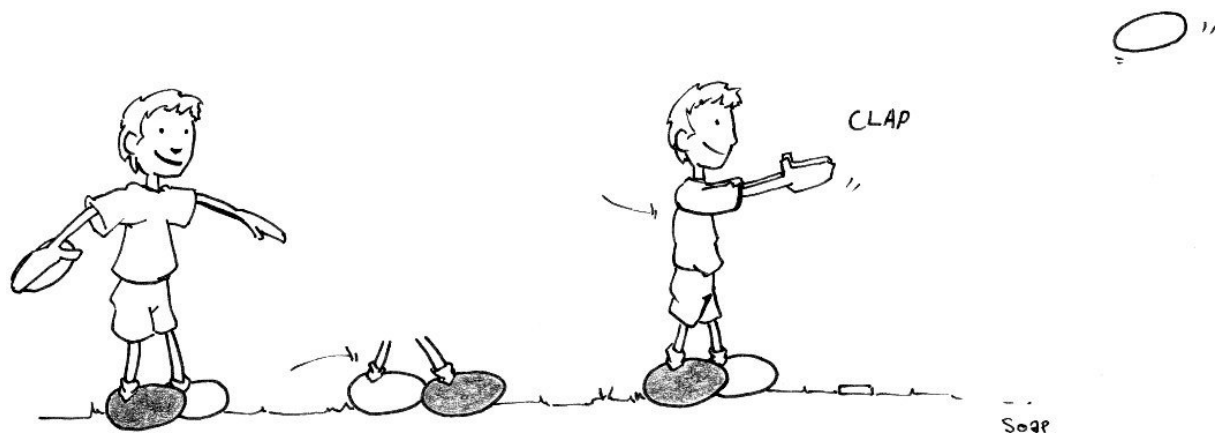

Instructions for the exercise:

- When the left foot lastly lands, the throwing implement should be maintained backwards
- Count the rhythm of the walking steps: long Left...quick Right Left
- Keep facing the throwing direction, the eyes looking in the same direction

Noticeable points:

- Successful throws
- General balance in the delivery phase
- Face the target during the delivery phase

Teaching progression:

- Vary the throwing implements
- Vary the distances
- Move towards games

Safety:

- Organisation of the group
- Well marked-out area

Equipment:

- Throwing implements
- Vertical markers
- Targets

EDUCATIONAL CARD: BACKWARD THROW

Analysis of the situation: This throwing event raises the problem of the coordination between arms and legs during the throw. Throw from a stable position with both feet. It requires a minimum mastery of the backward loss of balance.

Safety of the participants: To adjust the weight of the medicine-ball to the athletes' abilities.

They have to keep the chin over the chest. Provide a soft area for a possible backward landing (grass, mats, sand).

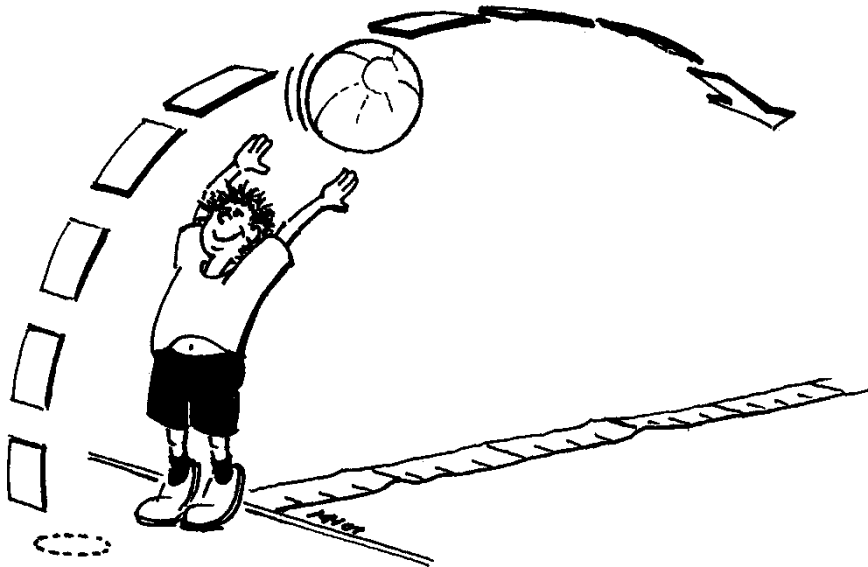

Event from the IAAF Kids' Athletics Competition
IAAF Figure

Educational Card 1: the Medicine-Ball Backward Throw

Objective: To experiment coordination during the throw

Proposed situation: Make the participants throw various medicine-balls up vertically with the full action of the body.

The beginner's behaviour: Beginners often tend not to use their legs/feet during the throw (they keep the heels down to the ground). The throw is not precise and vertical because of a too pronounced movement from the trunk/arms (result: they complete a backward throw).



Instructions for the exercise:

- Look at the ball after the delivery (there is a risk of shock upon landing)
- Use the whole body

Noticeable points:

- Regular vertical trajectory
- Use of the whole body (of the ankles among others)
- In the delivery phase, the whole body is in a vertical position
- Normal position of the head (the eyes looking forward) during the throw

Teaching progression:

- Vary the height of the throws
- Vary the throwing implements
- Catch the throwing implements after the throw (cushioning)
- Perform the throw with one hand
- Move towards games

Safety:

- Organisation of the group (area)
- Appropriate medicine-balls

Equipment:

- Medicine-balls
- Horizontal markers

Educational Card 2: the Medicine-Ball Backward Throw

Objective: To discover the back area

Proposed situation: To present to the young athletes a series of various exercises of backward loss of balance or backward movement.

The beginner's behaviour: Beginners tend to lean backwards in a bent position at the level of the pelvis, maintaining their head vertically to get their bearings. They are no longer in an efficient position (Push-off leg).

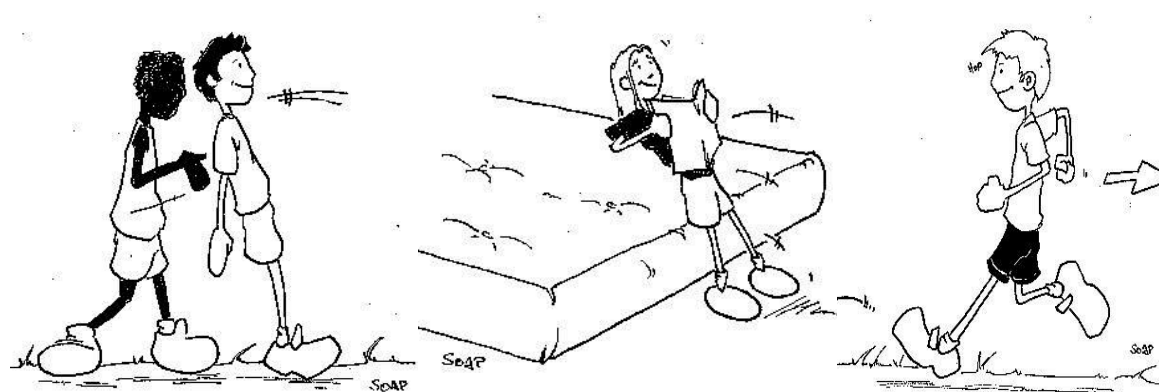

Instructions for the exercise:

- Make sure the back area is safe
- Lose balance with a straight body

For a successful throw:

- No apprehension about losing balance backwards
- Backward movement from an upright position
- The natural position of the head is maintained

Teaching progression:

- Repeat some playful exercises of backward loss of balance
- Move towards games

Safety:

- "Safe" back area
- Organisation of the group (area, individuals)

Equipment:

- Mats if necessary

Educational Card 3: the Medicine-Ball Backward Throw

Objective: To discover the throw from the back after a run-up

Proposed situation: Take a backward run-up and complete a throw.

The beginner's behaviour: Beginners move the hips backwards, not the whole body. They stop after the run-up phase to gain balance, and then carry out the throw.

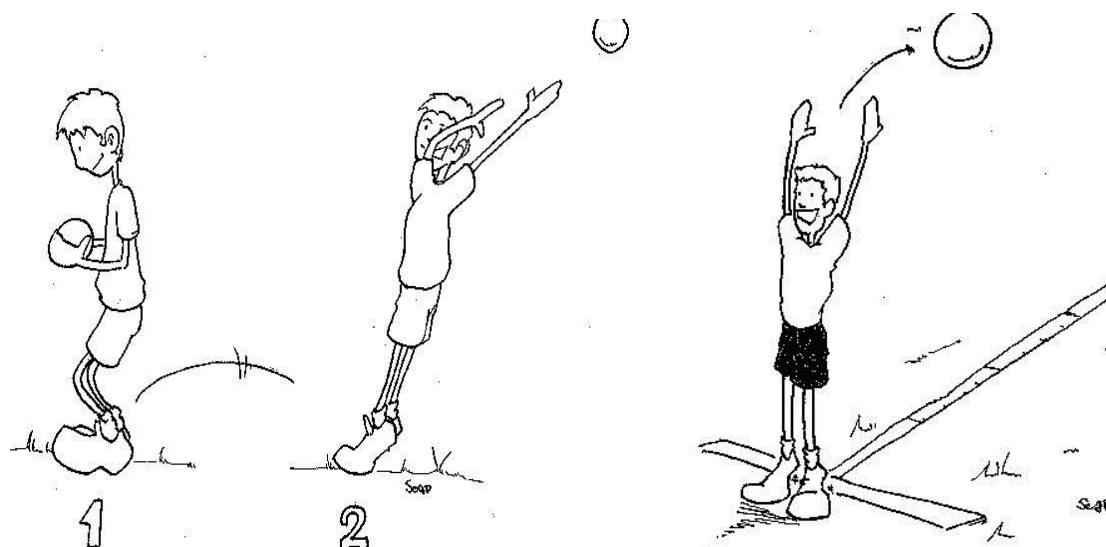

Instructions for the exercise:

- Check the back area (safety)
- Link the run-up/throw into a whole sequence
- Look at the landing of the implement

Noticeable points:

- Link the run-up/throw into a whole sequence (active landing)
- Throw at the selected target clearly marked out
- The body remains straight at the delivery phase

Teaching progression:

- Vary the throwing implements, the required distances
- Vary the running-up forms
- Move towards games

Safety:

- Safe run-up area
- Appropriate medicine-balls

Equipment:

- Medicine-balls
- Markers, targets and crossbars

Educational Card 4: the Medicine-Ball Backward Throw

Objective: To experiment the Medicine-Ball Forward Throw

Proposed situation: Make the participants complete a forward throw of a medicine-ball from a two feet position.

The beginner's behaviour: Beginners stay in an unsteady position on their feet and do not (hardly) use their lower limbs. Their hips move backwards when they quicken the medicine-ball with the arms.

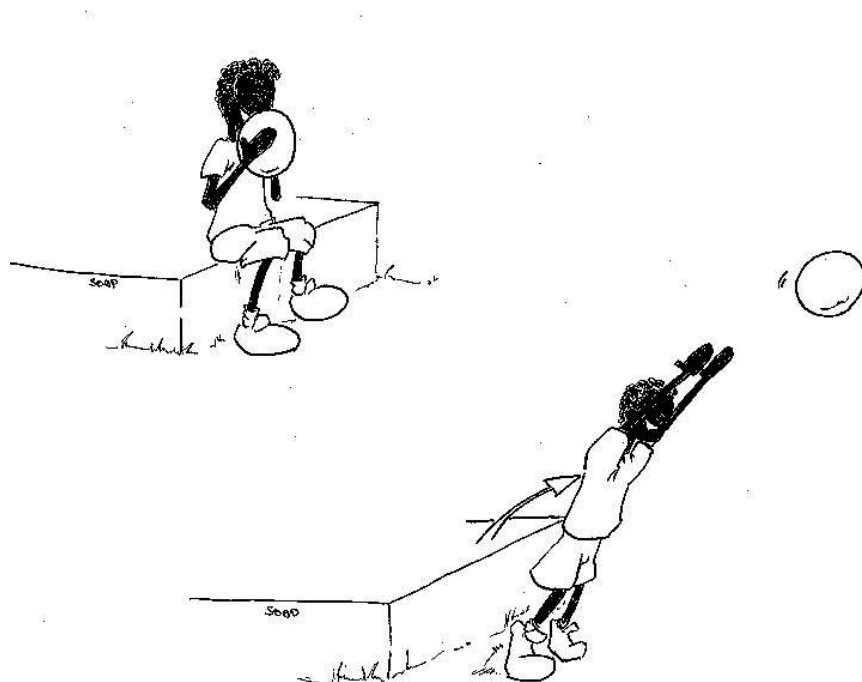

Instructions for the exercise:

- Lean forwards during the throw
- Activate the whole body

Noticeable points:

- Deliver the implement with a stretching movement from the ankles
- Throw at the selected precise trajectory (symmetrical throwing action)
- Lean forward upon delivery

Teaching progression:

- Vary the throwing implements (weight, form)
- Take a preliminary run-up with a two feet hop
- Vary the trajectories (high/low, far/near)

Safety:

- Appropriate Medicine-balls
- Non-slippery ground
- Organisation of the group

Equipment:

- Medicine-balls

Educational Card 5: the Medicine-Ball Backward Throw

Objective: To improve balance in the throw from the back

Proposed situation: Make the participants carry out backward throws of a medicine-ball with supporting limbs in the direction of the throw, or with one supporting leg (the weight of the implement is: 2kg maximum).

The beginner's behaviour: Beginners will find it difficult to stay in a stable position during such throws, and the rear leg may lack strength in the one-foot throwing action.



Instructions for the exercise:

- Be careful about balance
- Full extension of the body
- Throw backwards in the direction of the throw
- Lean in the direction of the throw after the delivery

Noticeable points:

- Throw in the selected trajectory
- Efficiency of the throw

Teaching progression:

- Take run-up (walking steps)
- Vary the implements
- Vary the trajectories
- Move towards games

Safety:

- Organisation of the group
- Appropriate medicine-balls

Equipment:

- Medicine-balls

EDUCATIONAL CARD: SHUTTLE SPRINT/HURDLES RACE

Analysis of the situation: This relay raises the major problem of the organisation of a sprinting event with obstacles at a very far distance. It presents once more the difficulty of speed coordination between the outgoing/incoming runners, the required ability for the changeover.

You have the possibility to use the training situations suggested for the “Bends Formula” Sprint Relay.

Safety of the participants: The ground should not be slippery. Takeover areas should be well organised and most of all, the obstacles should be safe.

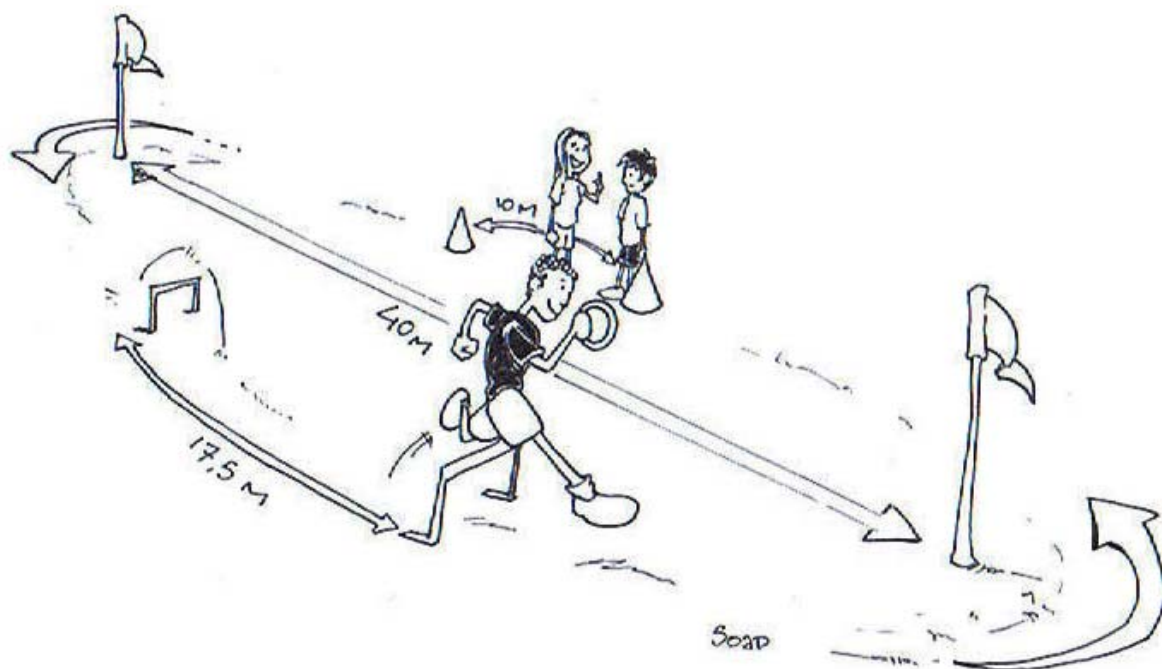

Event from the IAAF Kids' Athletics Competition

Educational Card 1: Shuttle Sprint/Hurdles Race

Objective: To organise the sprint over random intermediary distances

Proposed situation: Carry out distances with safe obstacles which are organised totally at random and with short or long spaces (from 3 to 15m).

The beginner's behaviour: Beginners adjust their pace to the various in-between distances, slowing down significantly before the obstacles. They often lose much speed at the touchdown after clearance (landing on both feet in a safe position).

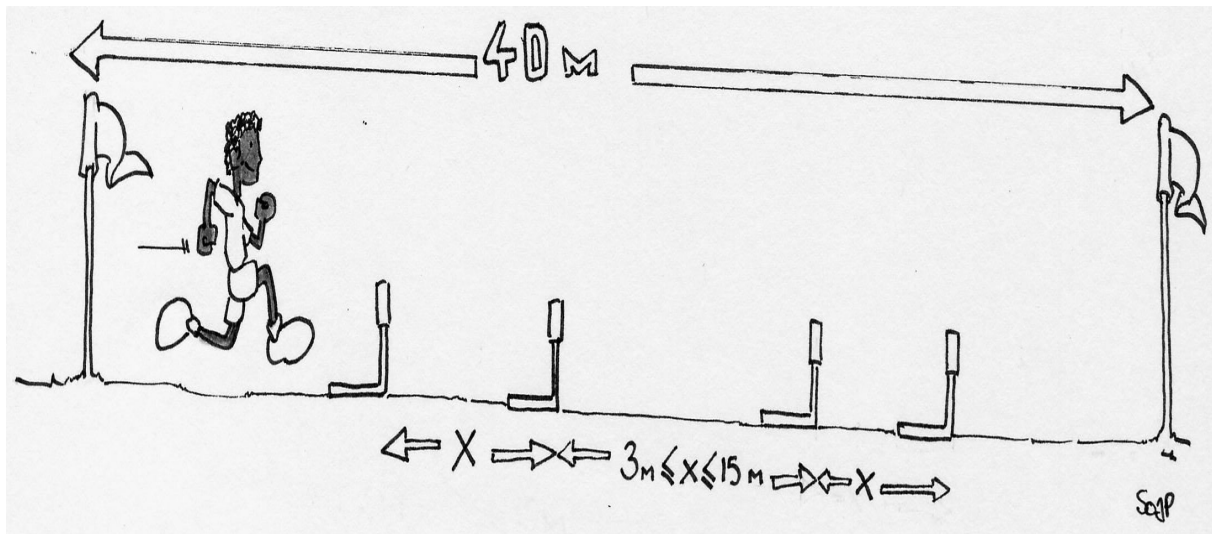

Instructions for the exercise:

- Run over the obstacles
- Vary and adjust your strides to the course

Noticeable points:

- No or hardly any loss of speed before the obstacles
- No important loss of balance
- Efficient transition to running after clearance

Teaching progression:

- Vary the height of the hurdles
- Vary the distances between the hurdles from 3m to 15m
- Vary the speed
- Move towards games

Safety:

- Non-slippery ground
- Safe obstacles
- Appropriate height hurdles

Equipment:

- Various obstacles
- Vertical markers

Educational Card 2: Shuttle Sprint/Hurdles Race

Objective: To improve the command of the distance between a banked corner and the first hurdle.

Proposed situation: Over various courses pass a banked corner to sprint to a safe obstacle. Distances as well as the curves of the corner are set at random.

The beginner's behaviour: Beginners wait until their last 3 or 4 strides to adjust for the obstacles often at the expense of a decrease in speed.

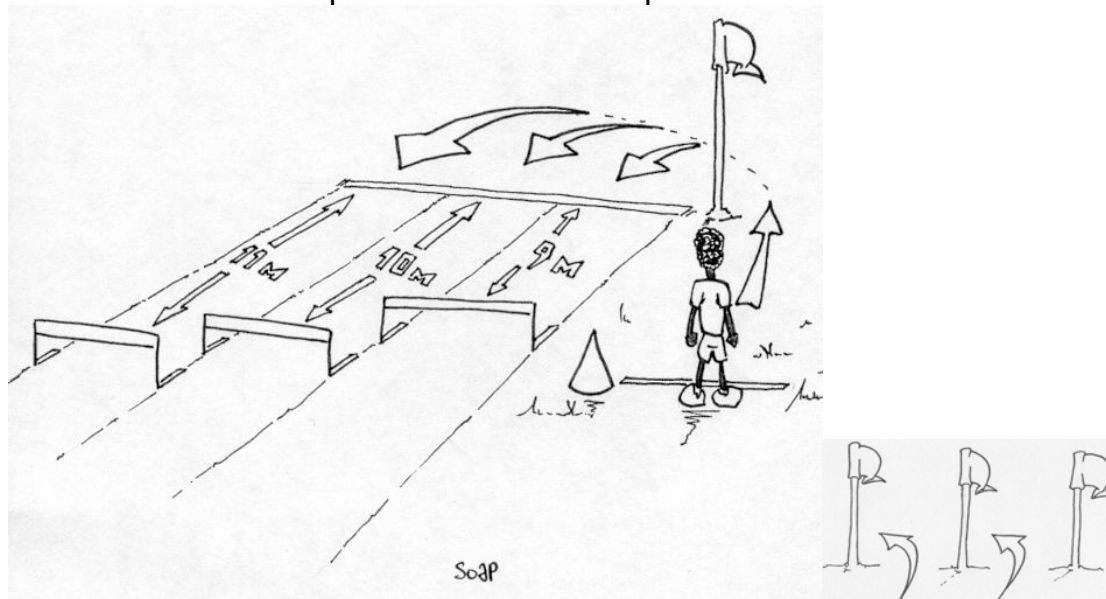

It is possible to use 2 or 3 gates to vary the curves.

Instructions for the exercise:

- Once you came out of the curve, get your bearings to the following hurdle
- Run various banked corners, using the various gates
- Active running transition after clearance

Noticeable points:

- No or hardly any loss of speed before the obstacles
- No important loss of balance
- Efficient transition to running after clearance
- Correct repetition of the exercise on the same distances

Teaching progression:

- Vary the height of the hurdles
- Vary the distances between the banked corner and the first hurdle
- Vary the speed
- Move towards games

Safety:

- Non-slippery ground
- Safe obstacles
- Appropriate height hurdles

Equipment:

- Various obstacles
- Vertical markers

Educational Card 3: Shuttle Sprint/Hurdles Race

Objective: To master the hurdles clearance with the right leg – the left leg

Proposed situation: Complete distances with safe hurdles placed at defined intervals to impose a 3 or 5 stride rhythm.

The beginner's behaviour: The beginners' reaction will be to run with even numbers of strides to make sure they will take off from the same foot. Complete a whole sequence of even and uneven numbers of strides remains very difficult.

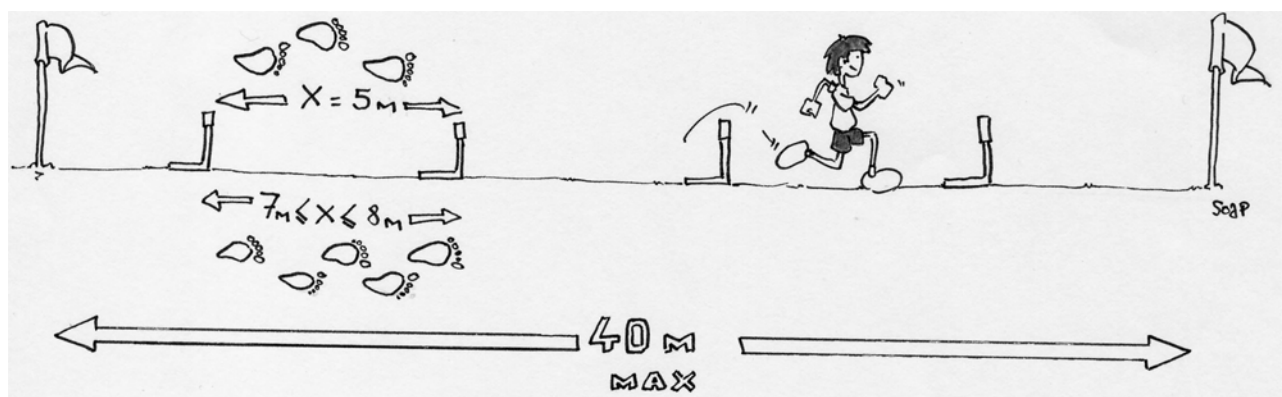

Instructions for the exercise:

- Remain at running speed between the obstacles
- Adjust your strides to the given spaces

Noticeable points:

- No or hardly any loss of speed before the obstacles
- No important loss of balance
- Efficient transition to running after clearance
- Correct repetition of the exercise on the same distances with respect to the given instructions in terms of the number of strides

Teaching progression:

- Vary the height of the hurdles
- Vary the intervals between hurdles to get 3 or 5 intermediary strides.
- Vary the speed
- Move towards games

Safety:

- Non-slippery ground
- Safe obstacles
- Appropriate height hurdles and in-between distances

Equipment:

- Various obstacles
- Vertical markers

Educational Card 4: Shuttle Sprint/Hurdles Race

Objective: To improve the baton handling

Proposed situation: Catch and release a baton (tennis ball, soft ring, relay baton, etc.) placed at pelvis level at running speed.

The beginner's behaviour: Beginners have great difficulty separating their arm's action from their running action. Their arm accompanies the sprinting movement and can not complete a precise action.

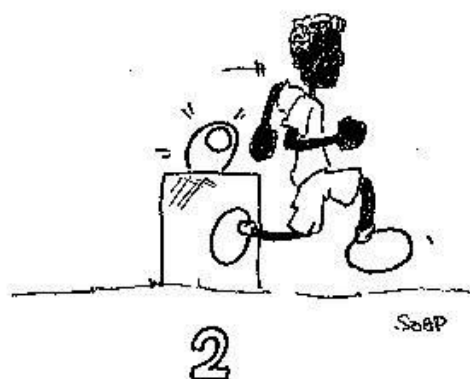
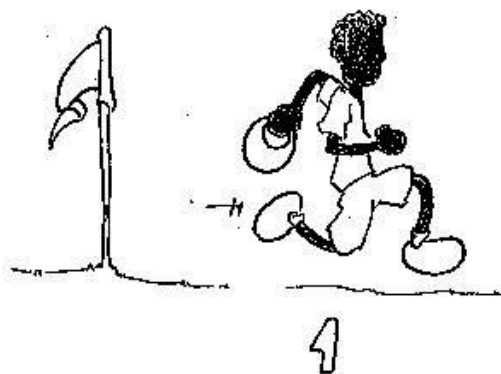

Instructions for the exercise:

- Remain in a relaxed position
- Do not turn the head towards the target

Noticeable points:

- Catching/Releasing the implements with precision and regularity
- No disruption in the sprinting movement (from the carrying arm only)
- No loss of speed during the exercise

Teaching progression:

- Vary the implements and the speed
- Use the right hand, the left hand
- Complete sequences : release/catch, catch/release
- Perform the exercise with changing hands
- Move towards games

Safety:

- Course without obstacles
- Organise the group
- Baton placed at the appropriate height

Equipment:

- Batons or various implements
- Support for relay batons

Educational Card 5: Shuttle Sprint/Hurdles Race

Objective: To improve the mastery of speed coordination

Proposed situation: On a marked-out course (starting and finishing lines) two children will start running at different moments from different places to cross the finishing line together. One child can cross the finishing line with a ball bowled on the ground by another participant.

This exercise should be repeated many times, collecting information from the right and left sides.

The beginner's behaviour: Beginners have difficulty evaluating the speed of the incoming runner; they often start running too early, too late or not fast enough.

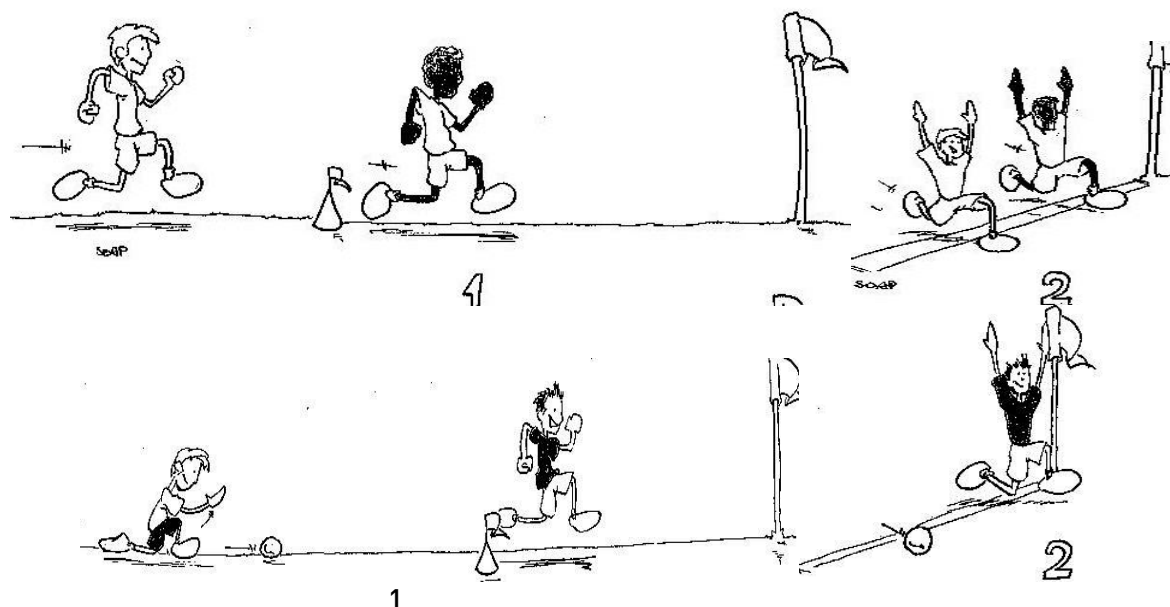

Instructions for the exercise:

- Look at the incoming runner until he/she reaches the check mark
- Start in the running direction

Noticeable points:

- Cross the line together with the bowling implement which serves as the model speed
- Acceleration in the required direction of the race
- Respected coordination in the acceleration phase

Teaching progression:

- Vary the implements and their speed to reach the check marks
- Decrease the time for collecting the information for the outgoing runner
- Disrupt the collect of information
- Move towards games

Safety:

- Regularly marked-out area
- Safe relay baton

Equipment:

- Various takeover implements
- Vertical markers on the area

EDUCATIONAL CARDS: SHUTTLE RELAY

Analysis of the situation: The shuttle relay requires specific abilities at maintaining maximum speed, the changeover mastery, and a minimum ability at evaluating speed and adjusting one's pace to other runners.

Safety of the participants: Safe ground; well-organised takeover areas, safe relay baton.

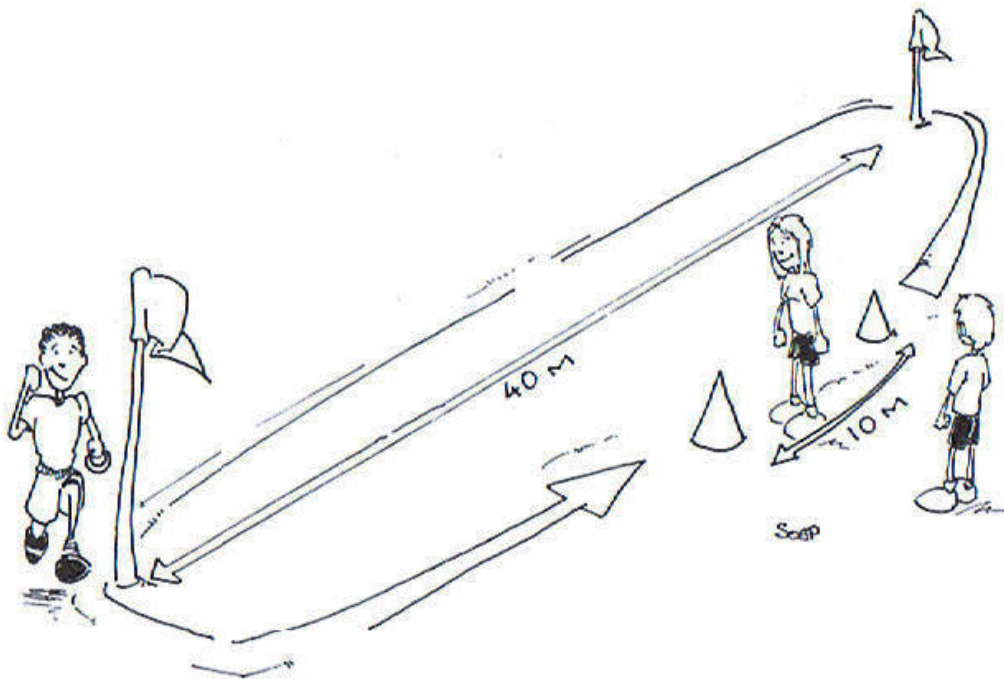

Event from IAAF Kids' Athletics Competition

Educational Card 1: Shuttle Relay

Objective: To improve the baton handling

Proposed situation: Catch and release a baton (tennis ball, soft ring, relay baton, etc.) placed at pelvis level at running speed.

The beginner's behaviour: Beginners have great difficulty separating their arm's action from their running action. Their arm accompanies the sprinting movement and can not complete a precise action.

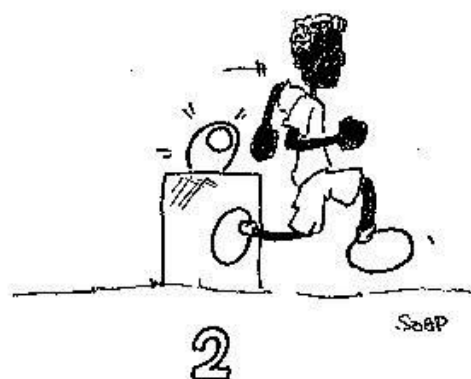
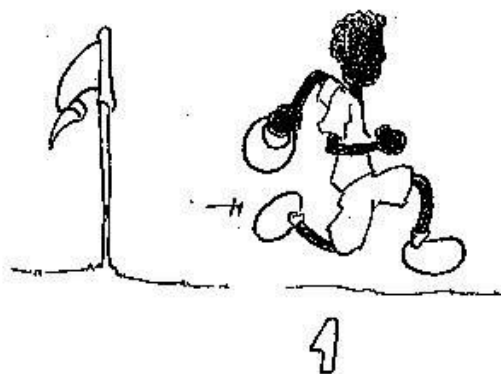

Instructions for the exercise:

- Remain in a relaxed position
- Do not turn the head towards the target

Noticeable points:

- Catching/Releasing the implements with precision and regularity
- No disruption in the sprinting movement (from the carrying arm only)
- No loss of speed during the exercise

Teaching progression:

- Vary the implements and the speed
- Use the right hand, the left hand
- Complete sequences : release/catch, catch/release
- Perform the exercise with changing hands
- Move towards games

Safety:

- Course without obstacles
- Organise the group
- Baton placed at the appropriate height

Equipment:

- Batons or various implements
- Support for relay batons

Educational Card 2: Shuttle Relay

Objective: To improve the mastery of speed coordination

Proposed situation: On a marked-out course (starting and finishing lines) two children will start running at different moments from different places to cross the finishing line together. One child can cross the finishing line with a ball bowled on the ground by another participant.

This exercise should be repeated many times, collecting information from the right and left sides.

The beginner's behaviour: Beginners have difficulty evaluating the speed of the incoming runner; they often start running too early, too late or not fast enough.

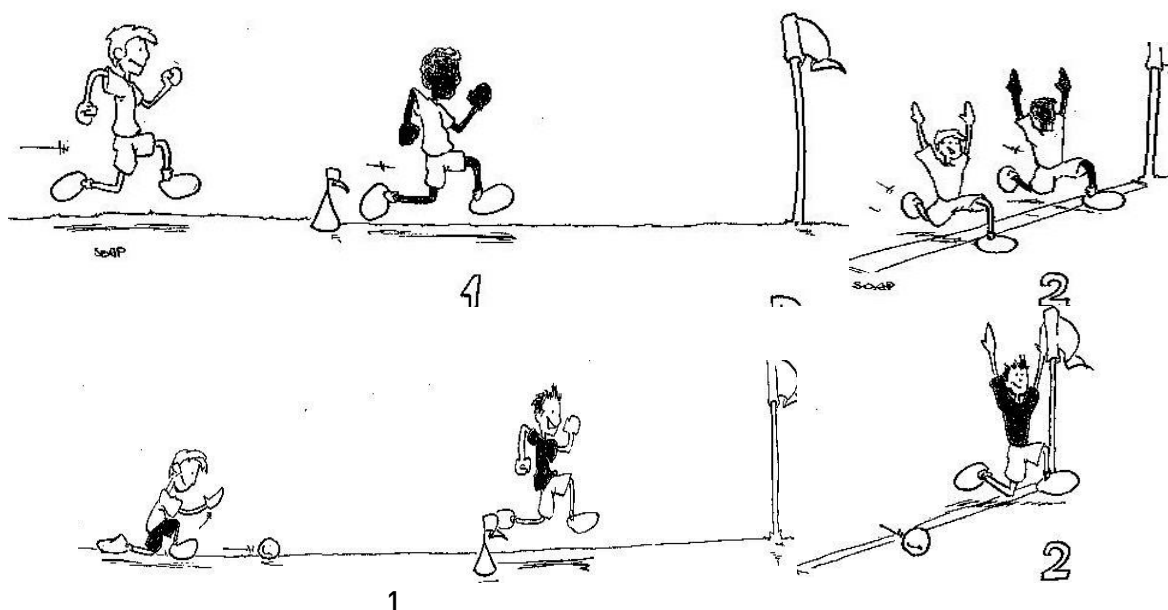

Instructions for the exercise:

- Look at the incoming runner until he/she reaches the check mark
- Start in the running direction

Noticeable points:

- Cross the line together with the bowling implement which serves as the model speed
- Acceleration in the required direction of the race
- Respected coordination in the acceleration phase

Teaching progression:

- Vary the implements and their speed to reach the check marks
- Decrease the time for collecting the information for the outgoing runner
- Disrupt the collect of information
- Move towards games

Safety:

- Regularly marked-out area
- Safe relay baton

Equipment:

- Various takeover implements
- Vertical markers on the area

Educational Card 3: Shuttle Relay

Objective: To discover how to run fast for a long time

Proposed situation: Have the children carry out courses with curves and turn back over a relatively long distance (40-50m). The about-turns will be achieved from the left and the right. The curves can be more or less large depending on the cones/markers set on the courses.

The beginner's behaviour: Beginners are unable to make an intense effort and maintain it over a quite long time. They are 100% active and lose much energy (contraction).

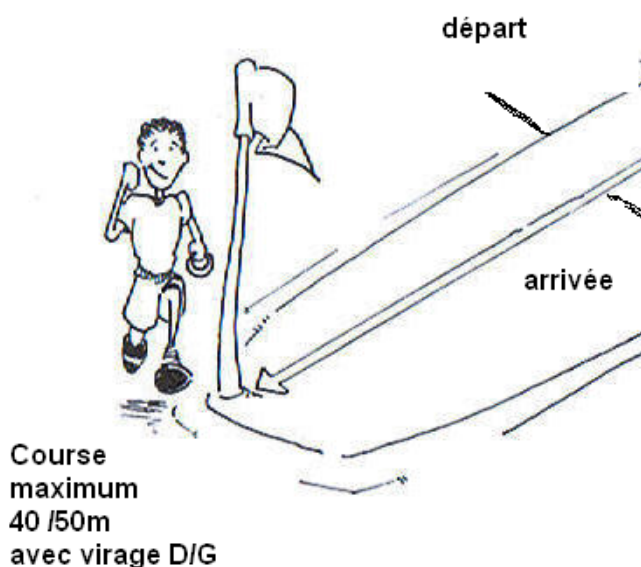

Instructions for the exercise:

- Run in a relaxed position
- Adjust your pace to a very quick run (different from 100% optimum speed)

Noticeable points:

- Good coordination in the about-turns
- Good time (Stopwatch)
- Run at consistent speed in curves (feet in the running direction, eyes look forward)

Teaching progression:

- Vary distances
- About-turn to the left, to the right
- Move towards games

Safety:

- Non-slippery track (bends)
- Appropriate recovery

Equipment:

- Vertical markers
- Horizontal markers (starting, finishing lines)

Educational Card 4: Shuttle Relay

Objective: To master the sprinting technique to run faster

Proposed situation: The participants have to carry out several courses marked out with crossbars at various distances; they will have to run the various distances to find their own running stride. Each child will run all the distances several times.

The beginner's behaviour: Beginners have difficulty changing their stride to run faster. Higher stride frequency often prevails over stride amplitude.

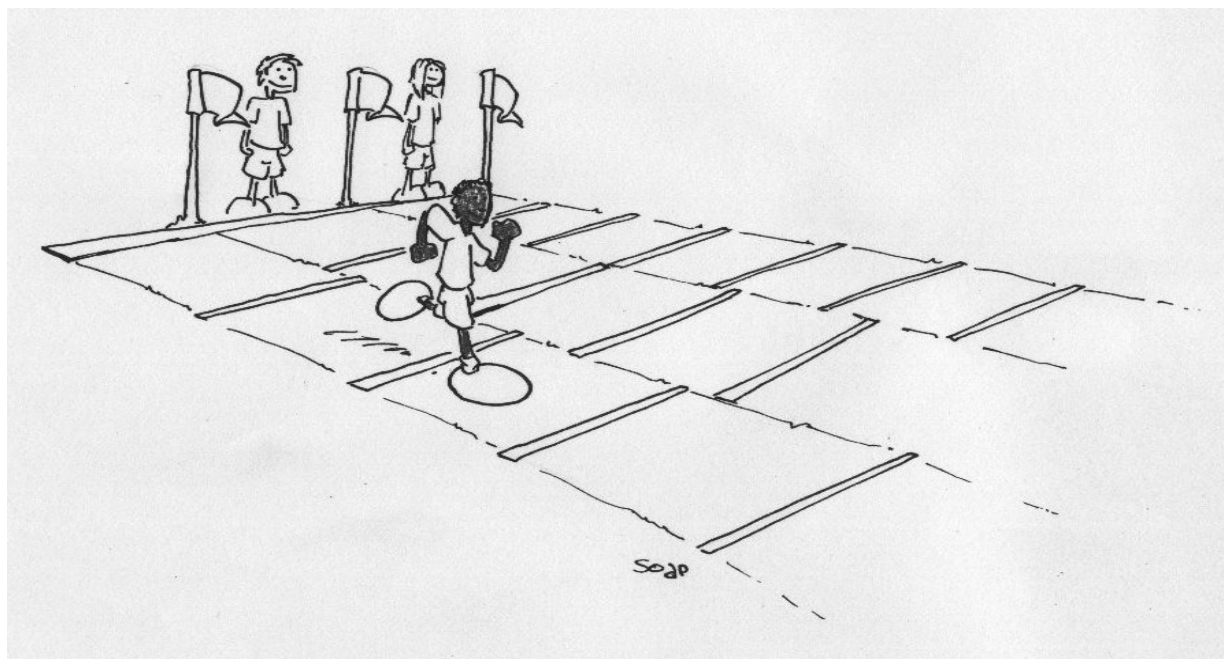

Instructions for the exercise:

- Run with the trunk in upright position
- Look for your maximum stride amplitude

Noticeable points:

- Provide large distances for running practice
- Be fast over various distances

Teaching progression:

- Vary the stride amplitude
- Enlarge the practicing area
- Keep the time
- Move towards games

Safety:

- Organise the group
- Non-slippery ground
- Safe markers

Equipment:

- Horizontal markers
- Vertical markers along the course

Educational Card 5: Shuttle Relay

Objective: To prepare for a quick active run and react at the starting signal

Proposed situation: Have the participants complete active reaction sequences using the appropriate resistance of a partner or an implement, and reacting as fast as possible to a sound or visual sign.

The beginner's behaviour: Beginners find it difficult to remain in a leaning forward position (the pelvis is held backwards by the rope). They also have difficulty developing the drive phase (lack of strength from the ground support).

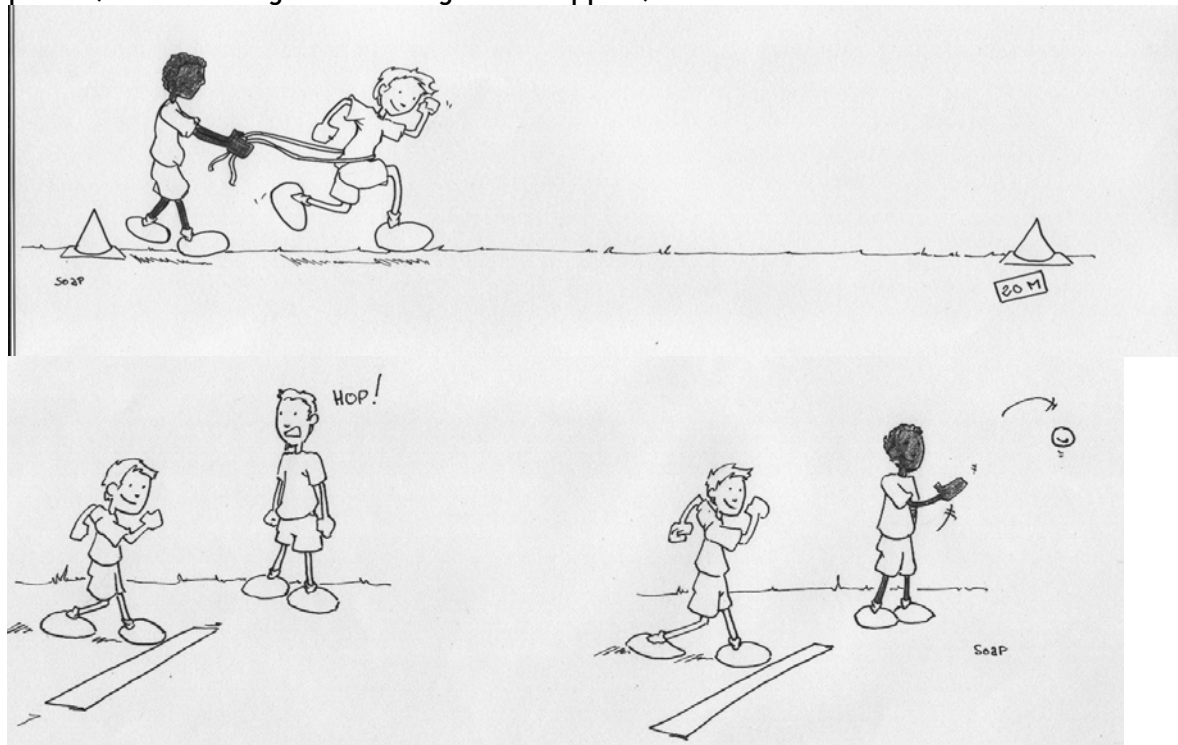

Noticeable behaviour:

- Body is bent at the pelvis level
- No full extension of support leg
- Upright position of the body

Teaching progression:

- Vary the resistance (always appropriate)
- Vary the distances
- Develop reaction speed thanks to sound or visual aids
- Move towards games

Safety:

- Non-slippery ground
- Instructions for moderate resistance
- Organise pairs of similar strength and weight

Equipment:

- Ropes or any implements
- Vertical markers

EDUCATIONAL CARDS : HURDLES RACE

Analysis of the situation: This is a team event in which each participant runs individually. The hurdles distances should match the below drawing, and the space between the starting line and the first hurdle should be large enough for the approach. The participant stands ready before the foul line to start when the starting signal is given. He/she completes the distance to cross the finishing line as fast as possible. Two participants run simultaneously over two parallel distances on the one starting signal.

Instructions for the safety of the participant: The hurdles should be safe and at the appropriate height. The ground must not be slippery and preferably a bit soft (turf for example).

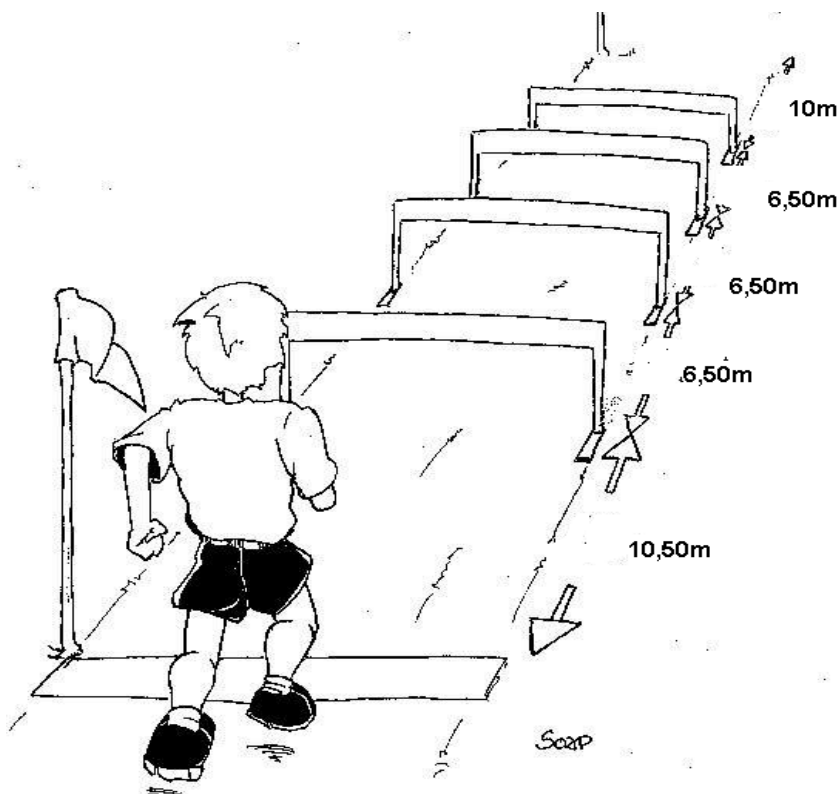

Educational Card 1: Hurdles Race

Objective: Basic command of the starting and sprinting to the first hurdle

Proposed situation: Have several courses at the athletes' disposal to practice the "starting-sprinting to the hurdle" sequence. After the clearance, impose an active transition to running. Gradually increase the distance between the hurdles in accordance to the event. Start from a standing position with shifted feet.

The beginner's behaviour: Beginners will accelerate to the hurdles then slow down before the obstacle to carry out a "safe" take-off. They often stand too close to the hurdle.

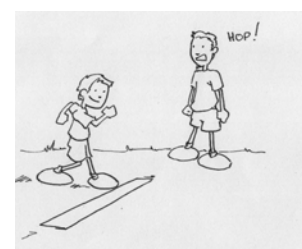
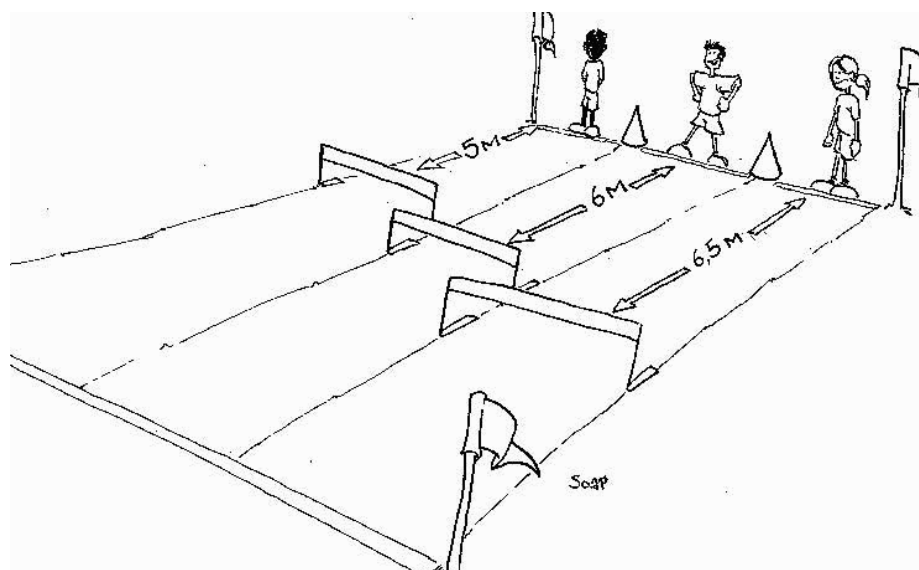

Starting position

Instructions for the exercise:

- Take-off is always from the same foot
- Accelerate progressively to the hurdle

Noticeable points:

- Regular run-up
- Adjustment of the strides to slightly varying distances
- Active transition to running after the clearance

Teaching progression:

- Gradually change the distance to get the equivalent distance of competition
- Run over the course with 4, then 6, then 8 strides
- Place a second hurdle at a correct distance
- Place markers in between the spaces
- Move towards games

Safety:

- Non-slippery ground
- Obstacles of appropriate height

Equipment:

- Obstacles
- Vertical markers (Running area)

Educational Card 2: Hurdles Race

Objective: To improve the hurdles clearance

Proposed situation: Complete distances with hurdles of varying height at very short intervals (1, 2 or 3 strides).

The beginner's behaviour: Beginners will feel very uncomfortable with the exercise. They would rather jump high over the hurdle than take trouble over a correct clearance and running.

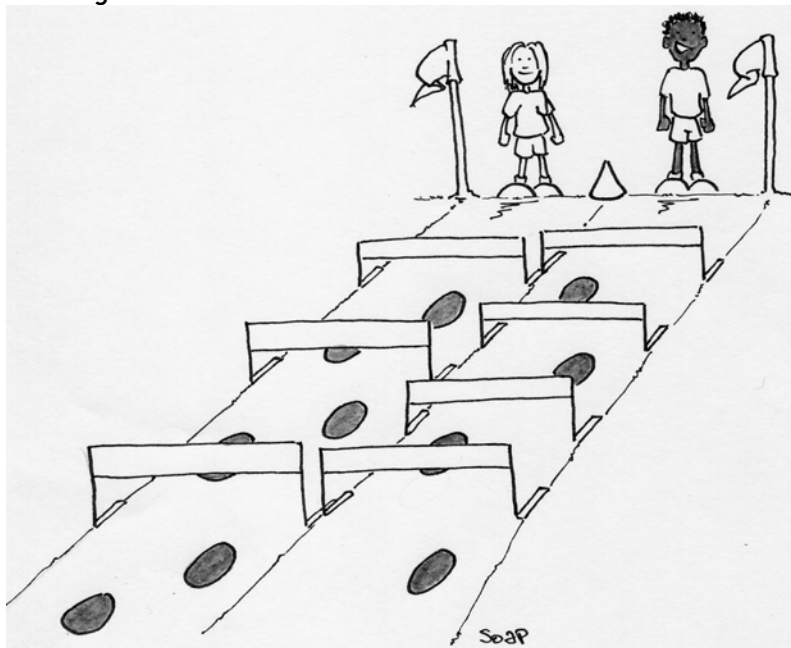

Instructions for the exercise:

- Do not rush during the first exercises
- Do not watch one's feet, nor the first hurdle ahead

Noticeable points:

- Proceed to a balanced position
- Arm action during the take-off
- The hip faces the trajectory/ the foot remains in the direction of running
- Maintain the speed

Teaching progression:

- Vary the height of hurdles up to the thighs
- Clear the hurdles with 2 then 3 strides in between
- Require to carry out the exercise without the arm action
- Vary the strides in between hurdles (strides, hops)
- Move towards games

Safety:

- Safe obstacles
- Organisation of the group (clearance)
- Appropriate height hurdles

Equipment:

- Obstacles
- Marked out distance

Educational Card 3: Hurdles Race

Objective: To run the distance between the hurdles

Proposed situation: Carry out in-between distances, to be gradually increased, with a constant number of strides. Proceed progressively (50cm difference at the most) from a very short distance to a limited distance.

The beginner's behaviour: Beginners have trouble running very short distances, as they often reduce the number of strides; and throughout the distance, they tend to moderate the speed instead of trying to accelerate in accordance with the gradual increasing of the in-between distance.

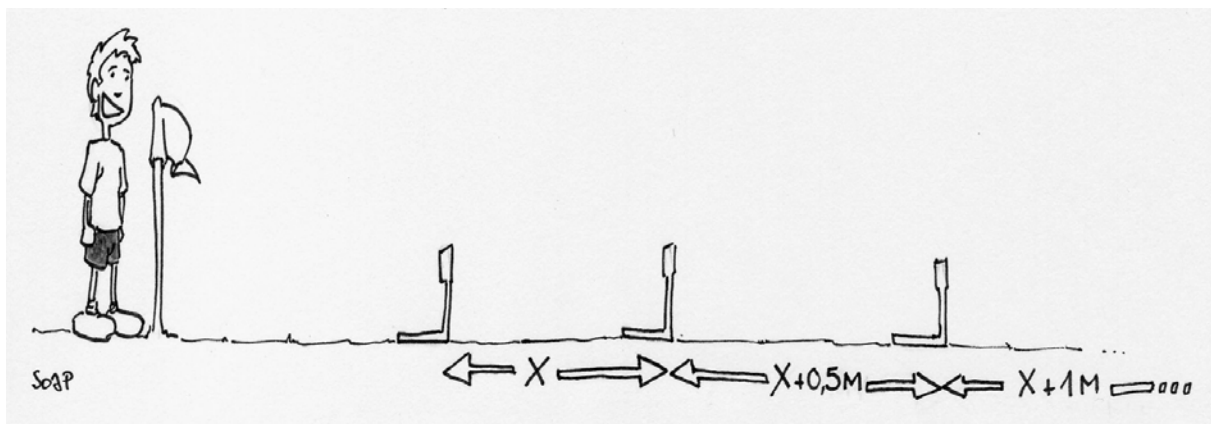

Instructions for the exercise:

- Run with a constant number of strides in between hurdles
- Keep the same stride frequency

Noticeable points:

- Improve the distance for clearance
- Keep a running mode (do not jump)
- Run the distance very gradually, with a "flowing" stride
- Always remain in a balanced position

Teaching progression:

- Vary the distances
- Vary the stride rhythm between hurdles (2, then 3, and 4 strides)
- Repeat the same exercise with hop-stride sequences
- Move towards Games

Safety:

- Safe obstacles
- Organisation of the group (clearance)
- Appropriate height hurdles
- Appropriate gradual progression

Equipment:

- Obstacles
- Markers for the distance

Educational Card 4: Hurdles Race

Objective: To increase the speed in between hurdles

Proposed situation: Achieve a sequence of in-between spaces to be linked with acceleration phases corresponding to two in-between spaces.

The beginner's behaviour: Beginners will be apprehensive about clearing hurdles at a high speed. Over the flat distances, beginners tend to run erratically to pick up speed.

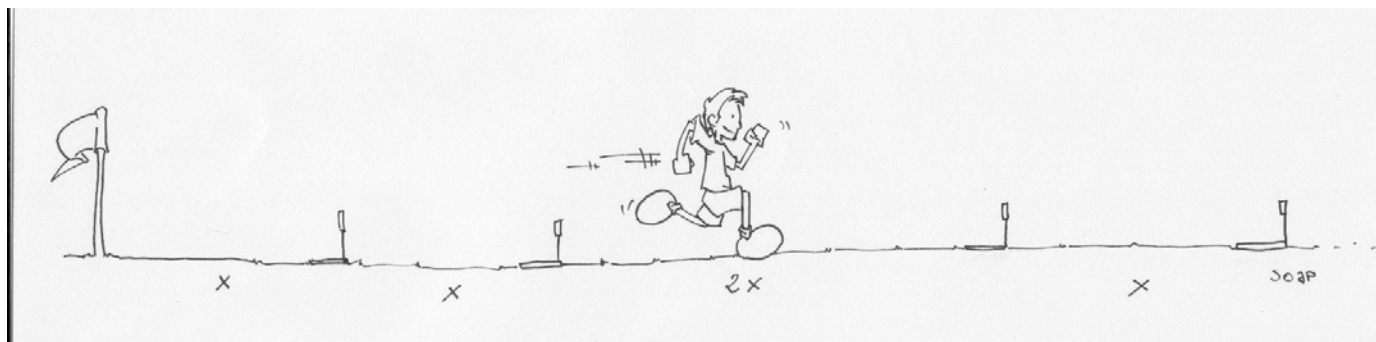

Instructions for the exercise:

- Speed up between the obstacles
- Remain in a balanced position at clearance

Noticeable points:

- Effective acceleration over in-between long distances (sprinting)
- General balance at clearance
- No slowing down as getting nearer the hurdles

Teaching progression:

- Vary the intervals between the hurdles
- Repeat the number of exercises
- Use a stopwatch

Safety:

- Safe hurdles
- Appropriate intervals
- Appropriate height hurdles

Equipment:

- Hurdles
- Vertical markers
- Stopwatches

Educational Card 5: Hurdles Race

Objective: Make progress in the mastery of the hurdles race

Proposed situation: The event from IAAF Kids' Athletics Competition is presented to the participants. Courses with 6m spaces (or even 5,50m) can be experimented, the starting line remaining at 10m from the first hurdle. Use sound and visual aids as starting signals.

The beginner's behaviour: Beginners will experiment the whole sequence of difficulties. The series of difficulties (starting/sprinting to the first hurdle, added to distances between hurdles) will force them to concentrate and repeat the exercise to make progress.

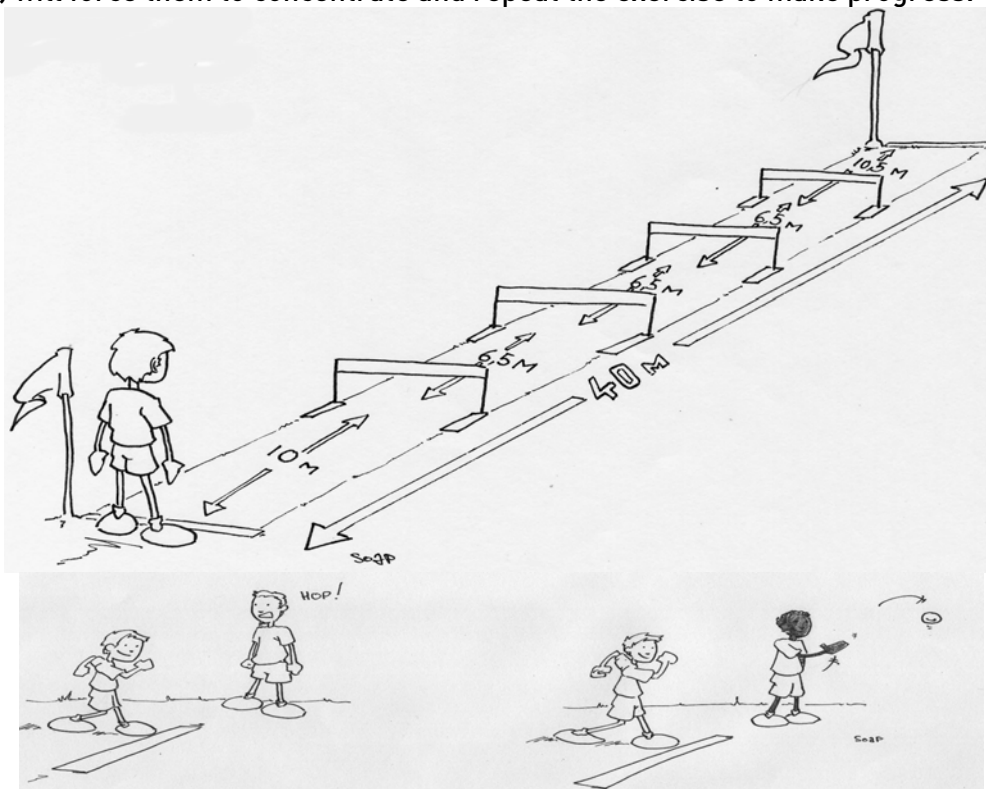

Instructions for the exercise:

- Try to make the most precise adjustment possible as to the starting/sprinting to the 1st hurdle question
- Pick up speed between the hurdles

Noticeable points:

- Perform the starting/sprinting to the 1st hurdle regularly
- Active running the in-between distances
- A stopwatch

Teaching progression:

- Vary the height of the hurdles
- Move to a duel, to a game

Safety:

- Well-organised group
- Clearly marked out station
- Appropriate height obstacles

Equipment:

- Hurdles
- Vertical markers
- A stopwatch

NB: This exercise should enable children to understand the rules and the organisation of the event.

EDUCATIONAL CARDS: TEENS' JAVELIN THROW

Analysis of the throwing practice: The aim of this throwing event is to achieve both performance and precision. An efficient motor approach is necessary to organise the event. It can be carried out with implements with minimum aerodynamic characteristics and easy to throw (advised weight: about 0,5kg).

Instructions for the safety of the participants: Throwers must play on a ground which is not slippery. Instructions for throwing are very strict and the throwing area is clearly marked out.

Finally, the throwing implements must be safe for the other children attending the event.

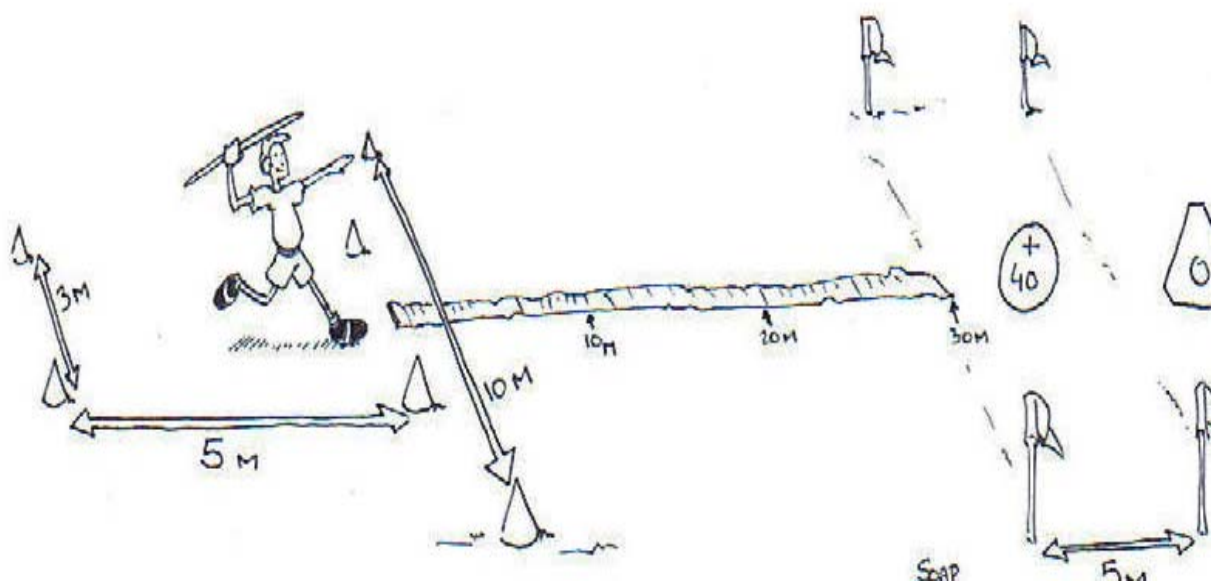

Event from IAAF Kids' Athletics Competition

Educational Card 1: Teens' Javelin Throw

Objective: Minimum command of the position and action of the throwing arm.

Proposed situation: Ask the young athletes to throw the javelin with both hands overhead, then with one hand, towards a definite target. The athletes should complete the throw from a standing position, hips facing the direction of the throw.

The beginner's behaviour: Beginners do not feel the extension of the shoulders and often position the tip of the javelin up. They do not memorise the position of the throwing arm to repeat it in the one arm throwing.



Instructions for the exercise:

- Lift the javelin up at the maximum
- Keep the pelvis in a fixed position

Noticeable points:

- Upon landing, the javelin's axis is in the direction of the throw
- The athlete keeps facing the direction of the throw
- The body's axis follows a straight line and leans forward
- Throw with one arm, keep the position of the throwing arm as during the two-arm throwing exercise (arms over the shoulders)

Teaching progression:

- Vary the throwing implements (weight, form, etc)
- Vary the targets
- Move towards games

Safety:

- Organisation of the group
- Instructions for the exercise
- Appropriate javelins

Equipment:

- Javelins with different weight
- Marked out targets

Educational Card 2: Teens' Javelin Throw

Objective: To improve the short run-up

Proposed situation: To propose the young athletes to throw the javelin after taking a run-up as follows: left, right, left foot (for a right-handed thrower). The throwing arm must be maintained high above the shoulder.

The beginner's behaviour: Beginners have difficulty coordinating the running up sequence with the throwing action itself. The proper grip of the javelin is a major difficulty for them.

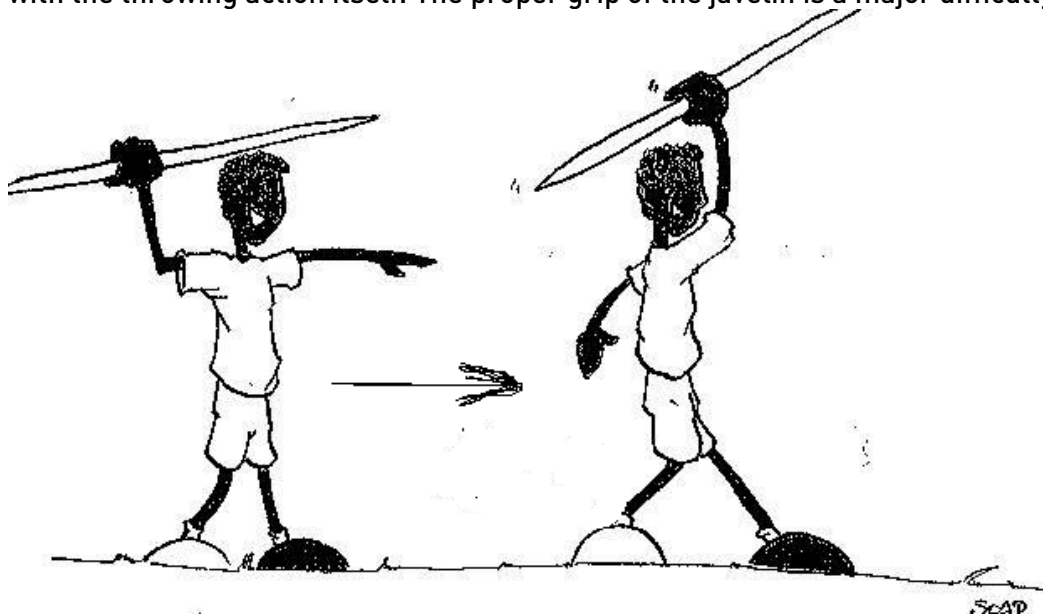

Instructions for the exercise:

- Keep the javelin overhead
- Mark the strides

Noticeable points:

- No lengthways rotation of the javelin before landing
- The axis of the body is directed on the throwing left foot
- When releasing the javelin, the athlete faces (pelvis/shoulders) the direction of the throw
- The thrower marks time to the run-up: left... ..right, left then throw

Teaching progression:

- vary the throwing implements
- throw towards various targets
- vary the forms and height of the trajectories
- organise games

Safety:

- Organisation of the group
- Instructions for the exercise
- Appropriate javelins

Equipment:

- Javelins of different weight
- Marked out targets

Educational Card 3: Teens' Javelin Throw

Objective: To improve the command of the throwing path

Proposed situation: Have the athletes carry out throws at the farthest distance possible with a special requirement as to preciseness. Such throws are completed after taking a short run-up (LRL).

The beginner's behaviour: Beginners often tend to rotate to be more efficient. The farther the target is, the more the javelin will turn aside.

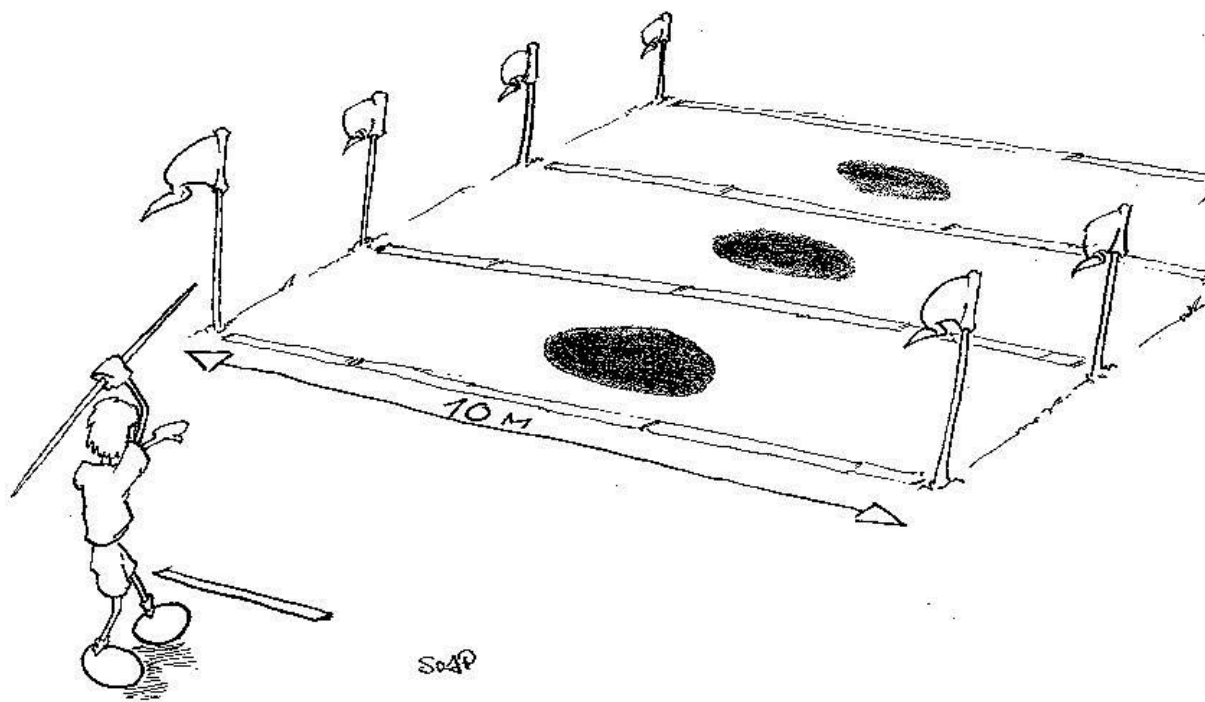

Instructions for the exercise:

- Be careful about the other participants
- Remain in the direction of the throw, throwing arms above the shoulders' level

Noticeable points:

- Respect the compulsory trajectories
- Respect the motor characteristics of a successful throw (body's axis facing the target, throwing arm above the shoulder)

Teaching progression:

- Increase distances
- Vary the throwing implements and sequences (far, near, medium distance)
- Move towards games

Safety:

- Organisation of the group
- Instructions for the exercise
- Appropriate javelins

Equipment:

- Javelins of various weight
- Marked out targets

Educational Card 4: Teens' Javelin Throw

Objective: To improve the quality of the run-up with the javelin

Proposed situation: Have the athletes link sequences of normal strides and/or crossover strides with the javelin in withdrawn position.

The beginner's behaviour: Beginners will have great difficulty completing effective crossover strides. The javelin, in withdrawn position, will often have unrestrained movements, or will turn aside from the direction of the throw significantly.

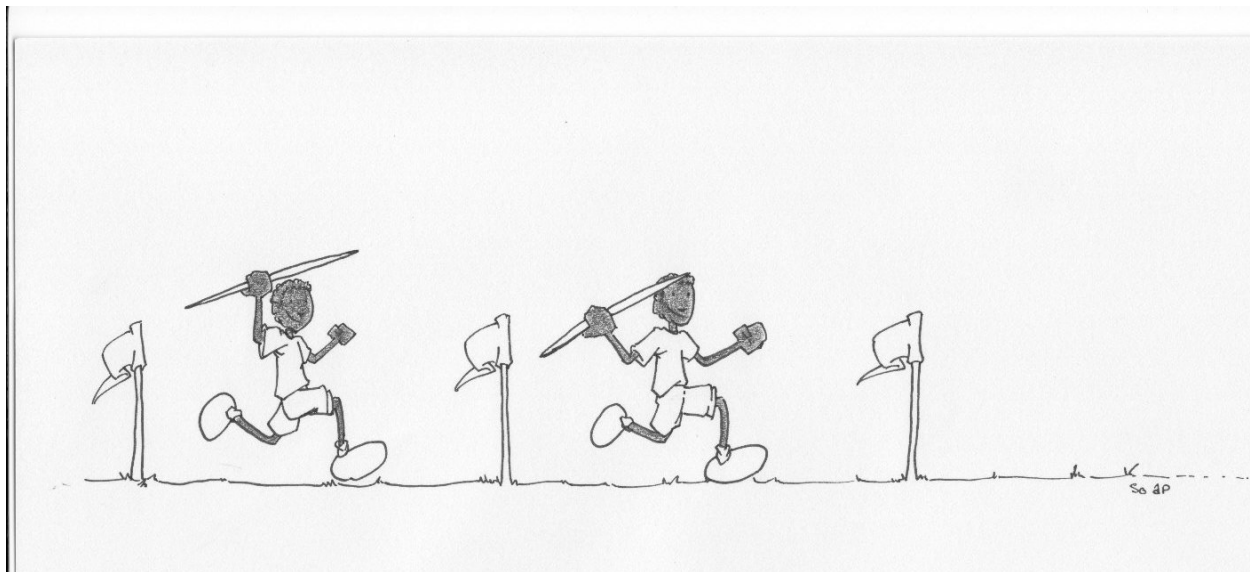

Instructions for the exercise:

- Isolate the javelin from the running-up action
- The stride rhythm is close to the running stride

Noticeable points:

- The javelin is maintained in a stable position and in the direction of the throw
- Efficient and balanced strides
- Remain in a straight path during the crossover strides

Teaching progression:

- Vary the running sequence
- Organise mixed courses with a side and a front run-up
- Throw from the left and the right arms
- Link-up throws to a target
- Move towards Games

Safety:

- Organisation of the group
- Safe javelins

Equipment:

- Javelins
- Horizontal markers

Educational Card 5: Teens' Javelin Throw

Objective: To organise a short run-up distance

Proposed situation: Over a speed ladder with marks every 50cm, the athlete will organise a specific run-up before throwing.

The beginner's behaviour: Beginners will have difficulty repeating similar run-up sequences. The grip and the organisation of the run-up (front strides and side strides) are actions hard to synchronise.

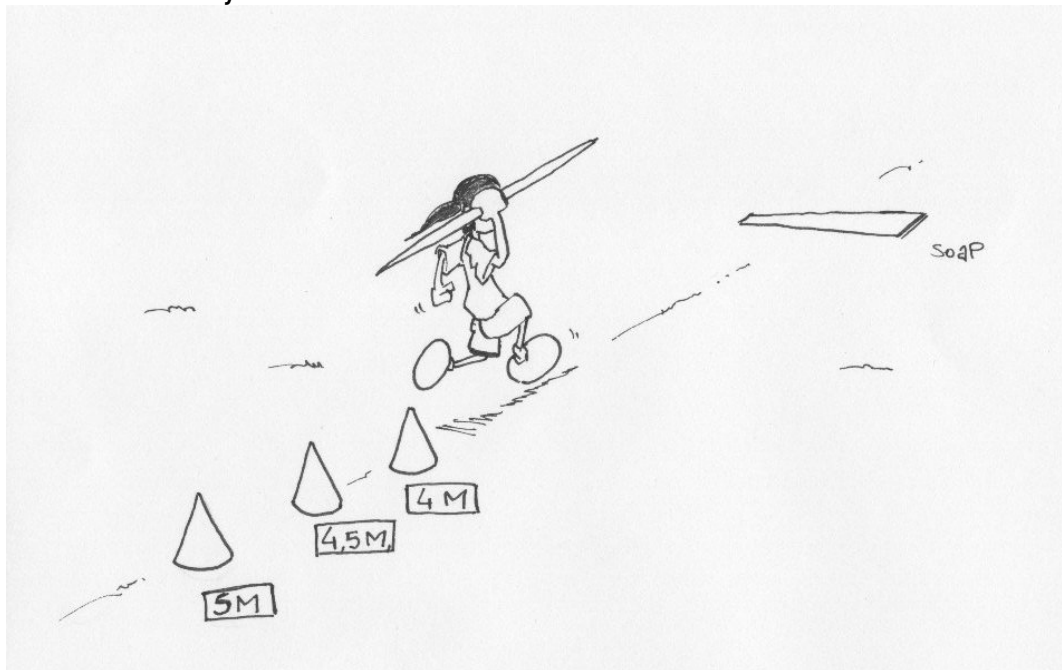

Instructions for the exercise:

- Select a run-up sequence
- Hold the javelin in the throwing position (at a shallow angle, high above head, forwards)

Noticeable points:

- Take regular run-up (form and distance)
- Correct grip of the javelin (diagonally and in the throwing direction)
- Keep the acceleration during the crossover stride sequence

Teaching progression:

- Link up throws for preciseness
- Practice with intermediate marks

Safety:

- Organisation of the group
- Safe javelins
- Priority is given to preciseness

Equipment:

- Javelins
- Horizontal markers
- Targets

EDUCATIONAL CARDS: TEENS' DISCUS THROW

Analysis of the situation of the event: The aim of this throwing event is to achieve both performance and precision of performance. An efficient motor approach is necessary to organise the event. It must be carried out with light implements (1kg maximum) which are easy to handle.

Instructions for the safety of the participants: Throwers must play on a ground which is not slippery. Instructions for throwing are very strict and the throwing area is clearly marked out.

Finally, the throwing objects need to be safe for the other children attending the event.

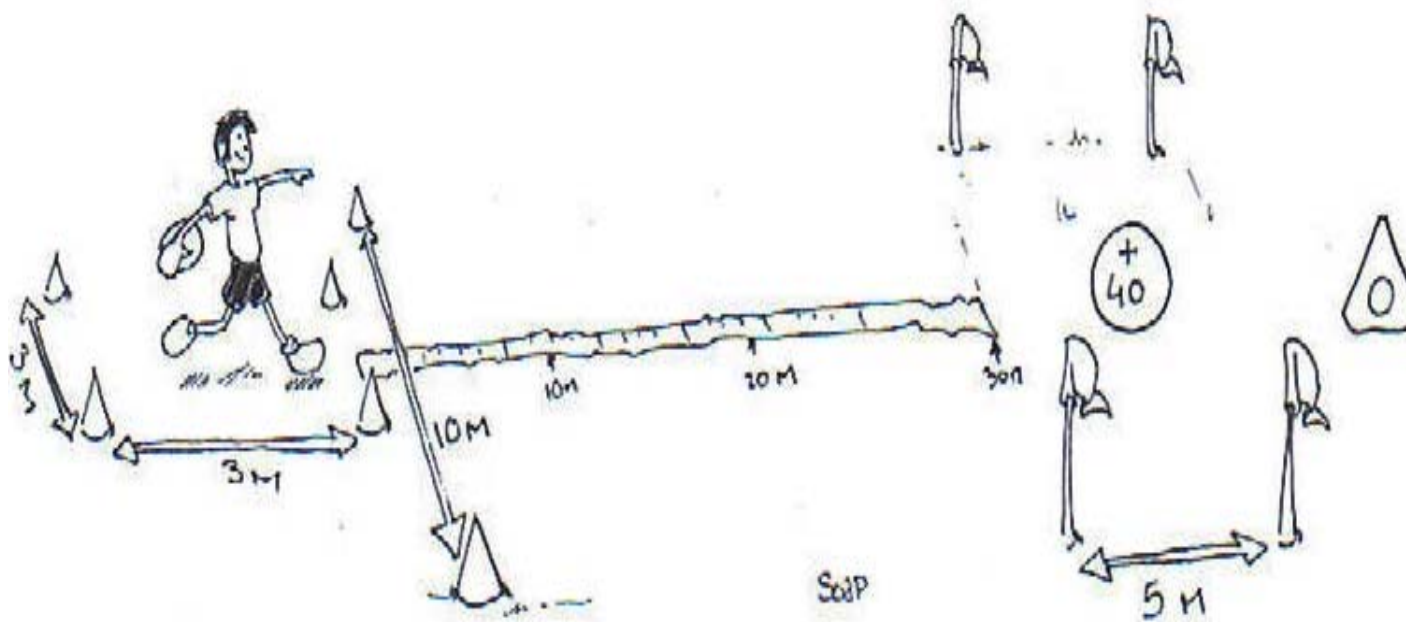

Event from IAAF Kids' Athletics Competition

Educational Card 1: Teens' Discus Throw

Objective: Minimum command of the grip, of the throwing arm's action and of the discus' direction following a walk-up.

Proposed situation: Propose youngsters to bowl the discus on the ground, then to throw the discus in the vertical axis of the rim, after taking a walk-up as follows: left, right, and left (for a right-handed thrower) in a clearly marked out direction.

The beginners' behaviour: beginners tend to hold the discus with the whole hand (thumb included). For a better command, he walks holding the discus along the thigh. Such position prevents him from completing an effective throw.

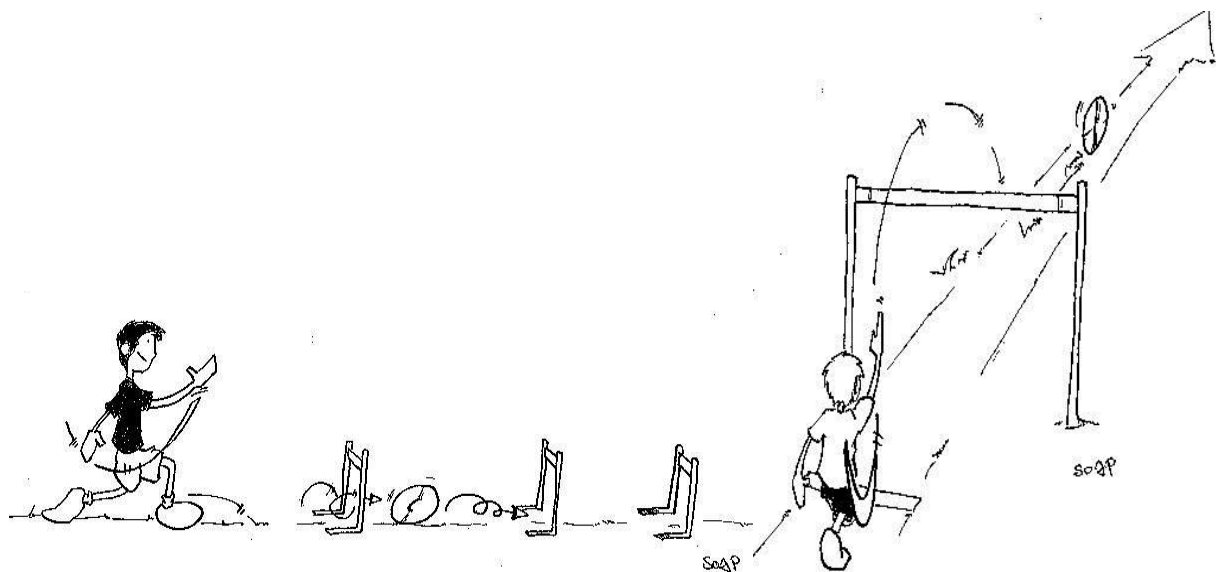

Instructions for the exercise:

- Legs are bent while throwing
- The throwing arm and shoulder are completely relaxed (no brutal movement)

Noticeable points:

- the athlete faces the throwing direction in a stable position
- body is blocked in the direction of the left foot/shoulder's axis
- the discus is rotated in the appropriate direction

Teaching progression:

- Vary the throwing implements (weight, form, etc)
- Vary the targets
- Move to playing activities

Safety:

- Well-organised area
- Organised group

Equipment:

- Discuses of different weight
- "Gate" equipment

Educational Card 2: Teens' Discus Throw

Objective: To improve the short run-up before a front one-turn throw

Standard situation: To propose the young throwers exercises on a running left-right-left-turn throw (for right-handed throwers). The throwing arm is constantly kept at shoulder height. The athlete remains stable throughout the throwing action.

The beginner's behaviour: Beginners often lose balance in the rotation. Body is rotated by the shoulders, which entails that the discus is swung in front of them. Throwers can not be efficient in this position.



Instructions for the exercise:

- Rotation of the body on the right foot (for right-handed thrower)
- Discus is kept away from the body

Noticeable points:

- Discus flies in the appropriate direction
- The axis of the body is directed on the throwing left foot
- Release the discus facing (pelvis/shoulders) the throwing area
- The thrower marks time to the run-up: Left.....right, left then throw

Teaching progression:

- Vary the implements
- Throw at various targets
- Vary trajectories: different forms and height
- Organise playing activities

Safety:

- Organisation of the group
- Well-organized area (target)
- 1st requirement: preciseness

Equipment:

- Discuses of different weight
- Targets

Educational Card 3: Teens' Discus Throw

Objective: To improve the control of the discus' trajectory

Proposed situation: Carry out throws at the farthest distance possible with a special requirement as to preciseness. Such throws are completed with a short run-up (LRL).

The beginner's behaviour: beginners have difficulty pacing themselves, especially because they do not make the proper movements. Balanced body positions are the key to achieve precise throws.

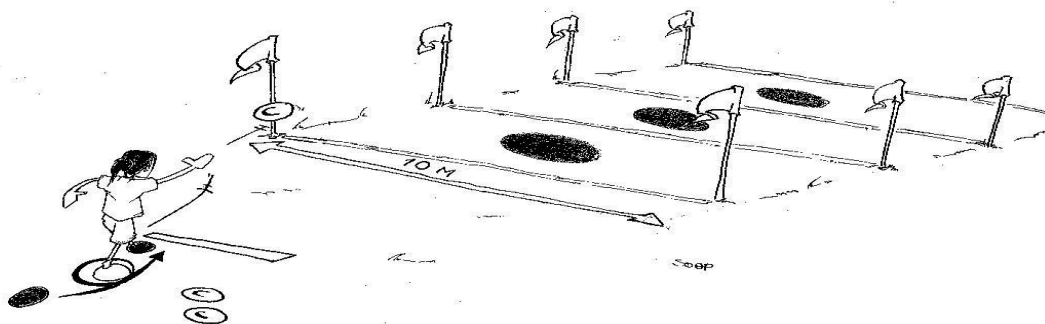

Instructions for the exercise:

- Control your actions
- Search for relaxation and balance

Noticeable points:

- Respect the compulsory trajectories
- Respect the motor characteristics of a successful throw (body's axis facing the target, throwing arm at shoulder height)

Teaching progression:

- Increase distances
- Vary throwing implements and sequences (far, near, medium distance)
- Move towards games

Safety:

- Well-organised area
- Instructions followed methodically
- adjustment to the difficulty

Equipment:

- Vertical markers
- Discs of various weight

Educational Card 4: Teens' Discus Throw with rotation

Objective: To improve acceleration of the discus with a rotational throw

Proposed situation: Starting with back facing the direction of the throw, one throws a medicine-ball over one's shoulder (right then left shoulder), the whole body being put to work (weight of the implements: 2kg maximum).

The beginner's behaviour: Beginners will stay with back facing the throwing area. He/she will often lose balance backwards after throwing.



Instructions for the exercise:

- Command the throwing implement with legs
- Right and left rotation of the body to carry out the throw

Noticeable points:

- Balanced body in the delivery phase
- Body facing the left while throwing over the left shoulder (and vice versa)
- Arms stretched upwards obliquely in the delivery phase

Teaching progression:

- Vary the implements (weight, form)
- Vary the compulsory distances
- Throw in the right and the left directions
- Move towards games

Safety:

- Organisation of the group
- Priority is given to the direction of the throw

Equipment:

- Various implements
- Vertical markers

Educational Card 5: Teens' Discus throw

Objective: To control the throwing whole sequence with front run-up

Proposed situation: After a 3m short run-up, the athlete will achieve a one-turn front throw. The throw is carried out in a given direction within a 10m wide area (maximum weight of the implement: 1kg).

The beginner's behaviour: Beginners will have precision difficulty throwing after a rotational run-up which often puts them in an imbalanced position. They often tend to rotate with head and shoulders.

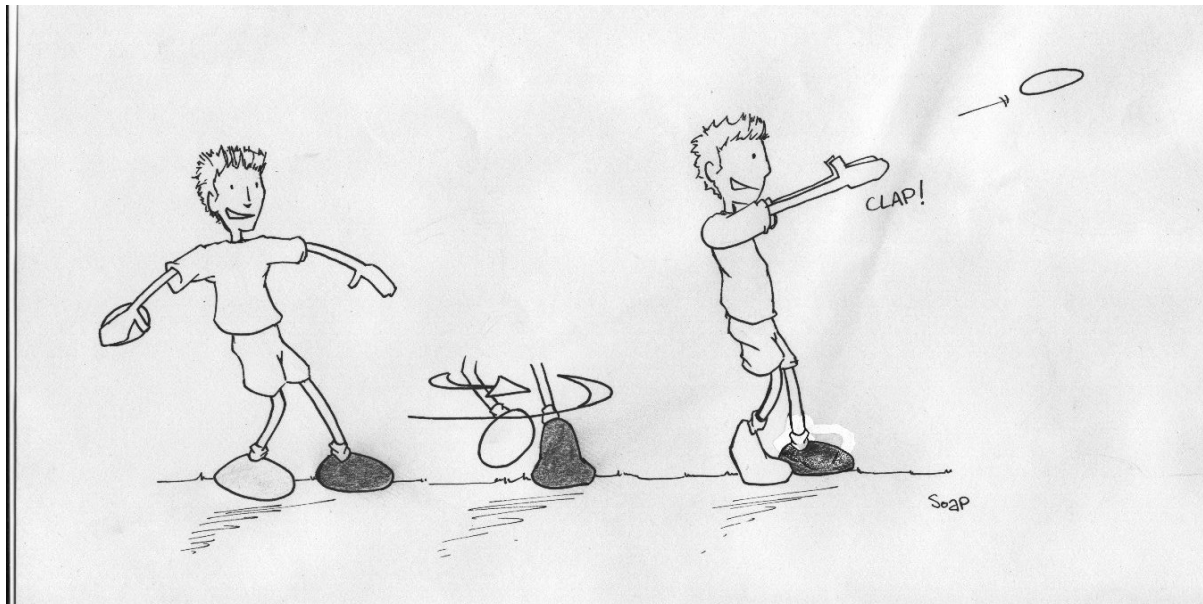

Instructions for the exercise:

- Command balance during the rotation (keep weight over the supporting legs)
- Wait to be facing the direction of the throw before swinging the discus forwards

Noticeable points:

- Throw in the appropriate direction
- Keep balance after throwing
- Discus is maintained away from the body throughout the throw

Teaching progression:

- Increase the requirements of performance and/or preciseness
- Vary the weight of implements
- Progression towards games

Safety:

- Organise the group
- Mark out the landing area

Equipment:

- Throwing implements
- Vertical markers

EDUCATIONAL CARDS: LONG JUMP FOR DISTANCE AND HEIGHT WITH A POLE

Analysis of the situation: The pole long jump requires that the athletes push the pole forward and take-off from the pole to achieve a great performance. Imposing a minimum height introduces them to the cultural dimension of the event.

Safety of the participants: Provide a soft ground, a landing area with sand preferably; ensure a precise landing hence the necessity to master balance. Finally, present this activity using appropriate poles (3m length maximum).

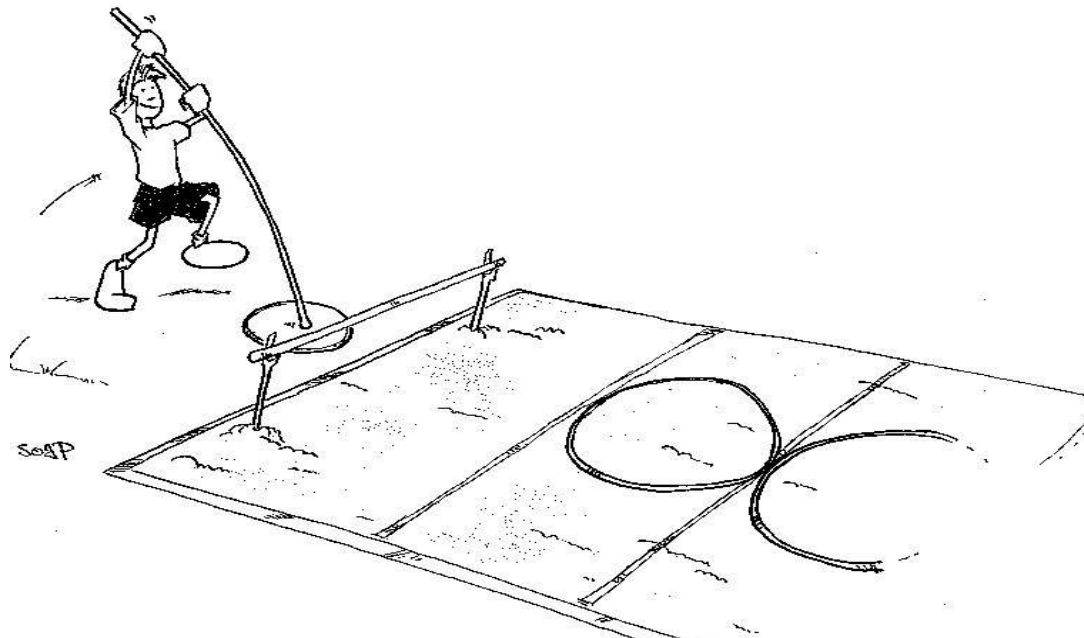

Event from the IAAF Kids' Athletics Competition

Educational Card 1: Long jump with a pole

Objective: To take-off from the pole to jump for distance

Proposed situation: From an extra-height surface, take-off forward from the pole to carry out a jump for precision and distance, passing over a safe obstacle (cardboard, foam mats).

The beginner's behaviour: Beginners do not push the pole forward and often drop the pole during the jump. The landing is not mastered and they experiment difficulty moving their feet up to clear the obstacle.

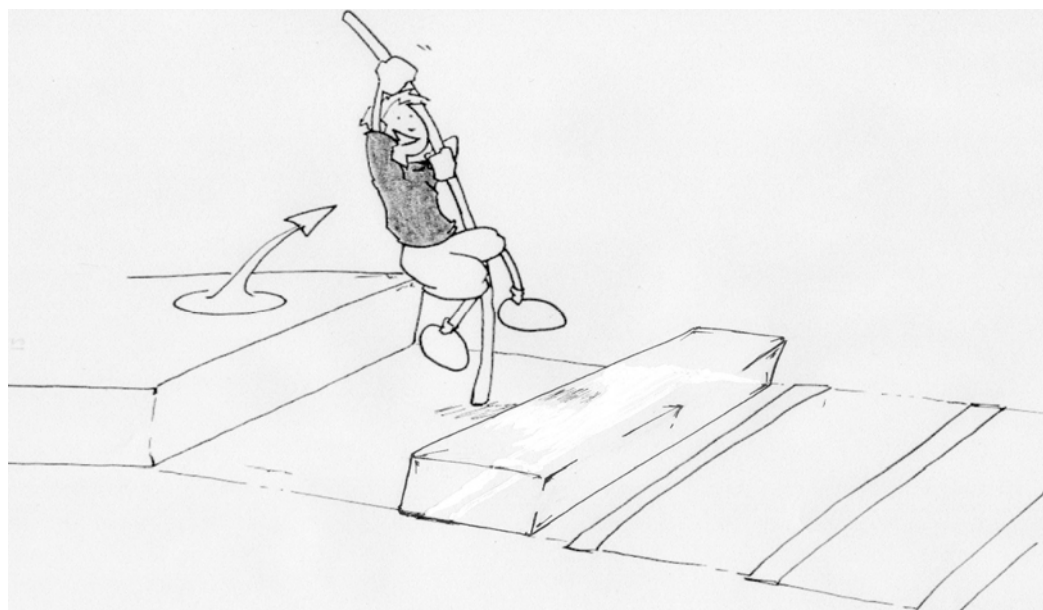

Instructions for the exercise:

- Push the pole forward
- Force the pole into the ground

Noticeable points:

- Landing in a balanced position (eyes looking forwards)
- Cushioning upon landing
- Long grasp of the pole with both hands

Teaching progression:

- Vary the trajectories (a quarter turn, about-turn, etc.)
- Vary the extra-height surfaces
- Require various performances
- Move towards games

Safety:

- A soft landing area
- A stable extra-height surface
- Adjust the height of the above structure
- Adjust the required distances

Equipment:

- Poles
- An extra-height structure
- Markers

Educational Card 2: Long jump with a pole

Objective: To experiment the sequence sprint/jump forward upward with a pole

Proposed situation: After a short approach length, link a forward and upward take-off into a sequence to achieve a jump over an extra-height surface. The participants are free to grasp the pole however they choose.

The beginner's behaviour: Beginners often tend not to use the pole to jump over the above structure. They try to jump directly from the ground, without taking-off from the pole.

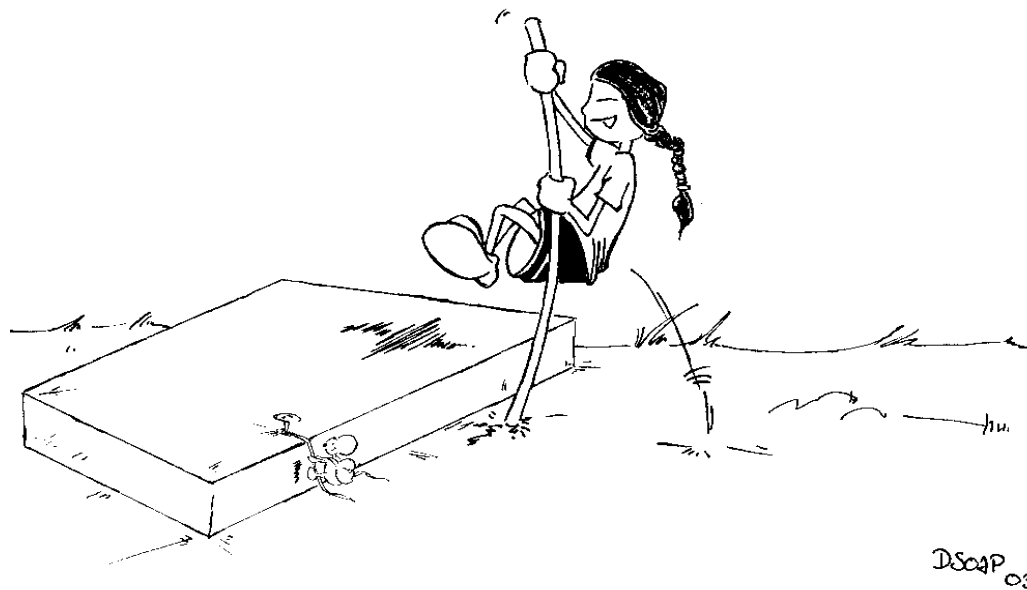

Instructions for the exercise:

- Take-off from the pole to get on the above surface
- Landing with both feet simultaneously

Noticeable points:

- Link Sprint / Jump into a sequence
- Mastery of the trajectory
- In the same axis: Take-off/Plant the pole/Landing in the direction of the jump

Teaching progression:

- Increasing height of the jump
- Vary the trajectories (about-turn, etc.)
- Move towards games

Safety:

- A stable extra-height surface
- Non-slippery ground
- Appropriate pole and lever

Equipment:

- Poles
- An extra-height structure
- Marked out approach area

Educational Card 3: Long jump with a pole

Objective: To experiment and improve the pole plant

Proposed situation: Link the running with the pole, carry position on one side, plant and take-off into a whole sequence. This exercise does not imply to actually carry out a jump, but it is demanding as the precision of the pole plant is concerned.

The beginner's behaviour: Beginners often lack precision in the exercise, and keep the pole at their shoulders' level most of the time. They have difficulty starting to take-off before jumping when the pole touches the target.

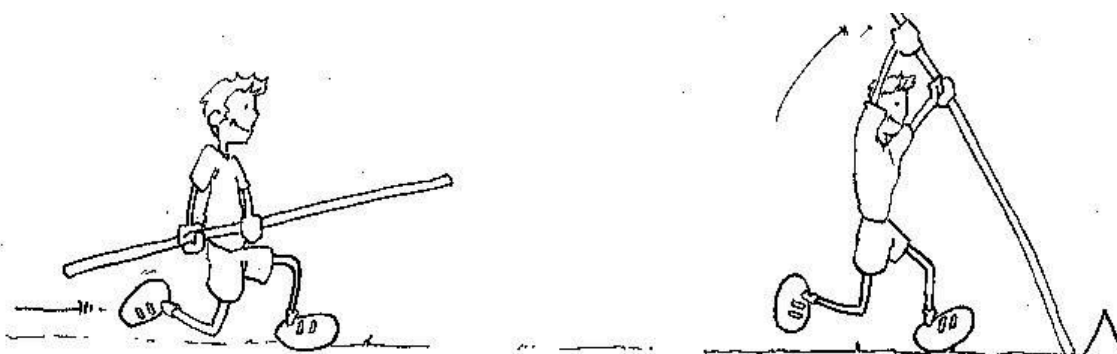

Instructions for the exercise:

- Link Run/Plant without breaking off
- Complete a forward take-off as soon as the pole reaches the target

Noticeable points:

- Running with the pole in a regular position
- Plant the pole right in the axis of the approach
- Rear arm is raised upwards in the plant phase
- Minimum loss of speed
- Take-off from the push-off foot planting the pole

Teaching progression:

- Repeat the same sequence Run/Plant several times
- Indicate the take-off area (box)
- Move towards games

Safety:

- Non-slippery ground
- Appropriate poles (regular length)
- Appropriate speed

Equipment:

- Poles
- Take-off "box", targets (cones, etc.)

Educational Card 4: Long jump with a pole

Objective: To improve the approach run with the pole.

Proposed situation: Achieve a whole series of approach runs with the pole.

The beginner's behaviour: Beginners do not manage to “isolate” the running action from the carrying of the pole. The pole has unrestrained movements during the run.

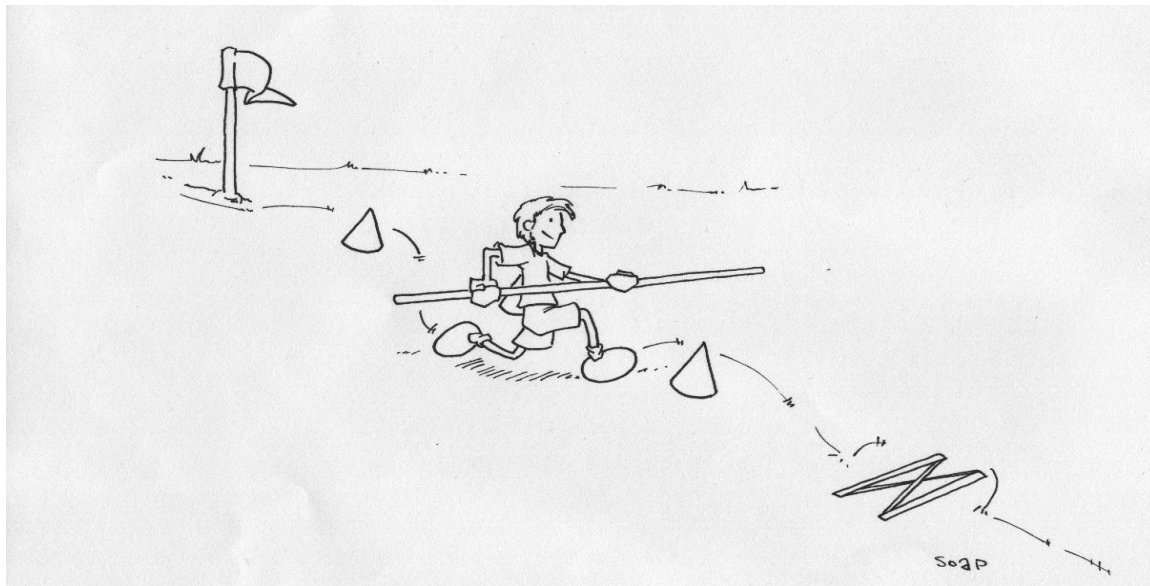

Instructions for the exercise:

- Run with relaxed shoulders
- Hold the pole in the running direction

Noticeable points:

- The pole is maintained in the running direction in a stable position
- Complete a proper run

Teaching progression:

- Present as many exercises as possible
- Increase the speed
- Move towards games

Safety:

- Organise the group
- Appropriate poles

Equipment:

- Poles
- Vertical markers
- Horizontal markers

Educational Card 5: Long jump with a pole

Objective: To organise a short approach

Proposed situation: On a marked out area, with markers every 30cm, the participants have to organise a regular and precise approach to achieve a jump for distance and height.

The beginner's behaviour: Beginners have difficulty repeating regular approaches. They do not master the "Run/Plant" sequence.

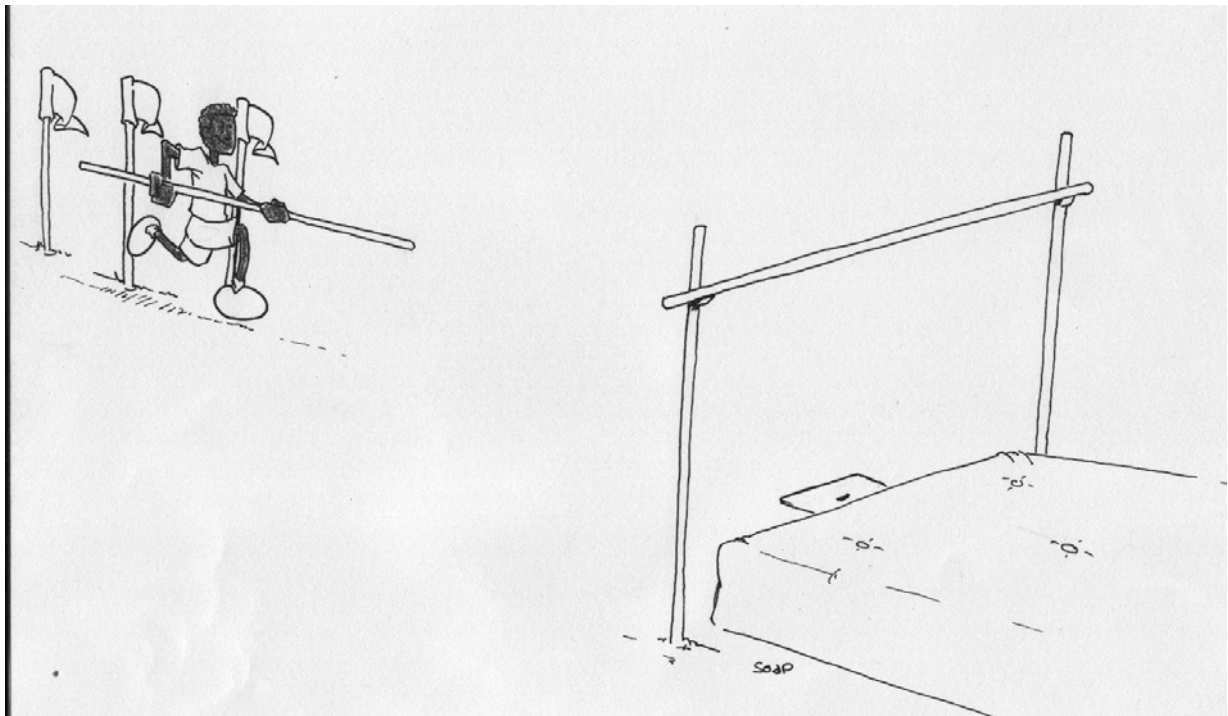

Instructions for the exercise:

- Accelerate progressively
- Maintain the pole in the jumping direction

Noticeable points:

- Regular run
- Link the Run/Plant/Jump into a whole sequence
- Do not slow down before jumping

Teaching progression:

- Provide a crossbar, or any similar implement (elastic)
- Provide an intermediary marker

Safety:

- Soft landing area
- "Appropriate" run-up area

Equipment:

- Poles
- Horizontal markers

Technical Card for pole-vaulters

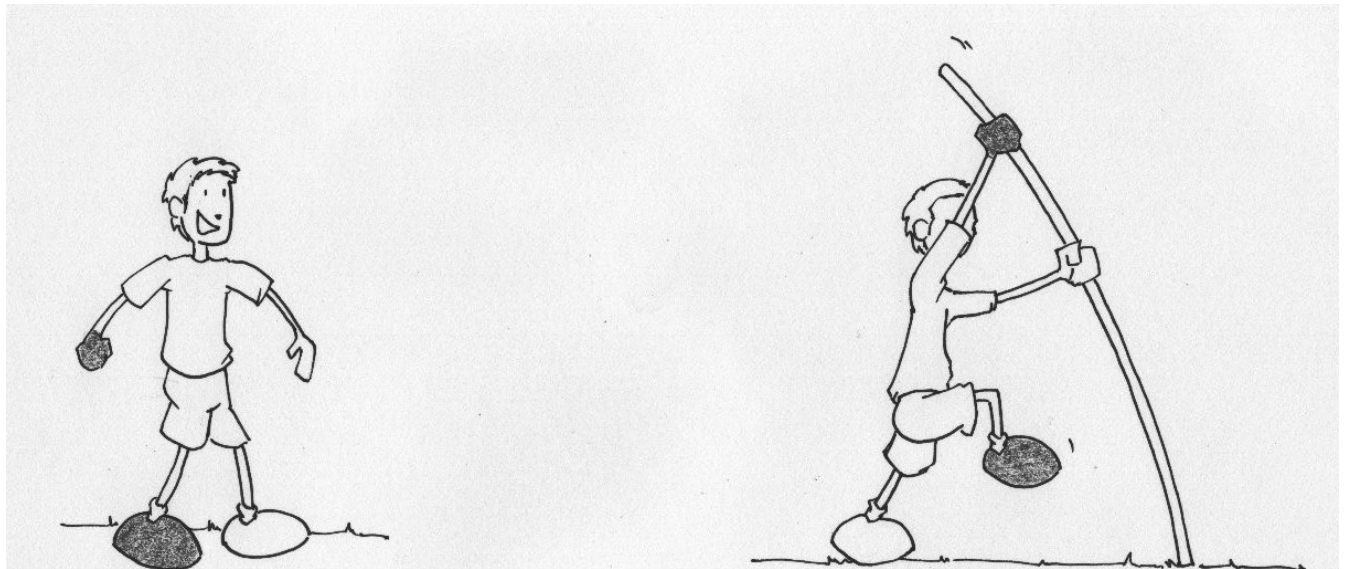

To achieve a regular pole vault, a specific organisation of the take-off arm/foot needs to be respected.

For throwers who take-off from the left foot (see above figure), the higher hand is the right hand, and vice versa for throwers with the right take-off foot.

Tricks for the safety of participants and the educational effectiveness:

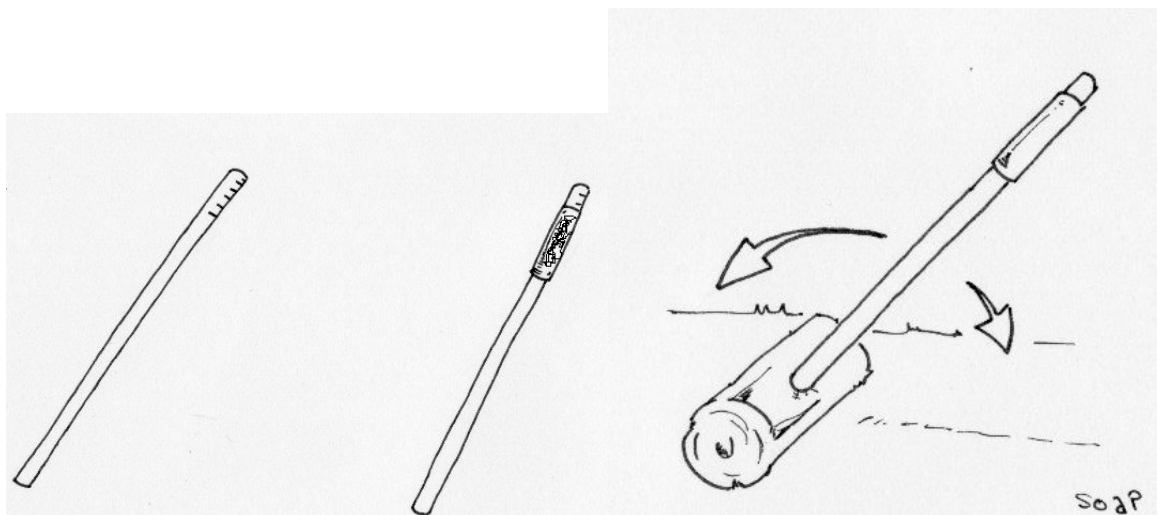

A scale
For a correct grip

A sleeve
To indicate the distance
Between the hands

A stump or piece of wood
To maintain the athletes in the
the axis in lower down jumps

EDUCATIONAL CARDS: TRIPLE JUMP AND LONG JUMP WITH A SHORT RUN-UP

Analysis of the jumping practice: The triple jump and long jump after a short approach require a minimum mastery of precision in the approach, the hopping technique, and the hop/step sequence.

The hop/step practice is efficient to discover the support balance.

Safety of the participants: There are two guarantees for safety:

- Carry out the jumping exercises on a soft and non-slippery ground.
- Focus the efforts on the technique before working on the performance.

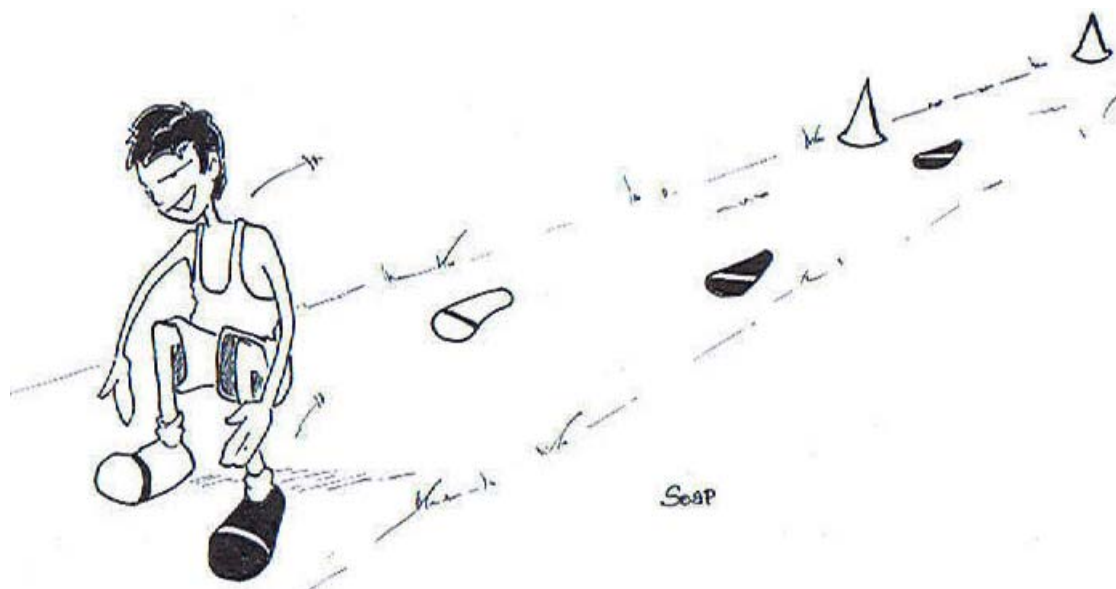

Event from IAAF Kids' Athletics Competition

NB: In all training situations for multiple jumping events, "the jumping regularity" will be the priority.

Educational Card 1: Triple Jump and Long Jump with short run-up

Objective: To improve the take-off precision

Proposed situation: Complete forward jumps with a short run-up to improve precision in the support placement. The obstacles will be mainly horizontal so as not to force the participants to jump high.

The beginner's behaviour: To gain precision, beginners slow down before the jumping area and look at the ground, turning aside from the regular general jumping behaviour.

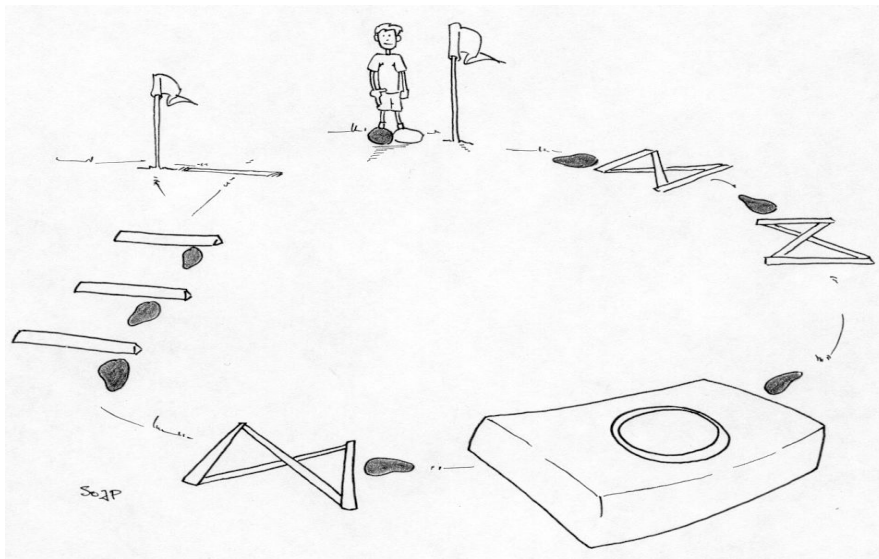

Instructions for the exercise:

- Do not look at the ground
- Link the jumping and the running phases into a whole sequence

Noticeable points:

- Precise foot placement
- No loss of speed before jumping
- Landing at running speed

Teaching progression:

- Vary the distances between rivers (keep short distance – 10m)
- Modify the width of rivers when possible
- Carry out take-off from the right foot and the left foot
- Carry out landing on right foot hopping and left foot hopping
- Move towards games

Safety:

- Soft ground
- Safe and non-slippery markers

Equipment:

- Jumping markers
- Markers on the course

*** This training situation is valid for the limited triple jumping event.**

Educational Card 2: Triple Jump and Long Jump with short run-up

Objective: To experiment and master the hopping technique

Proposed situation: Discover and improve the hopping technique through various sequences of exercises. First, the jumping area will be limited for a better achievement.
Example: Hopping sequence over a whole marked-out distance.

The beginner's behaviour: Once beginners faced the basic coordination problem of the hopping technique, they very often lose balance sideways while hopping as the body weight is not over the support leg. They often do not coordinate their arms with the hops and "block" them to gain balance.

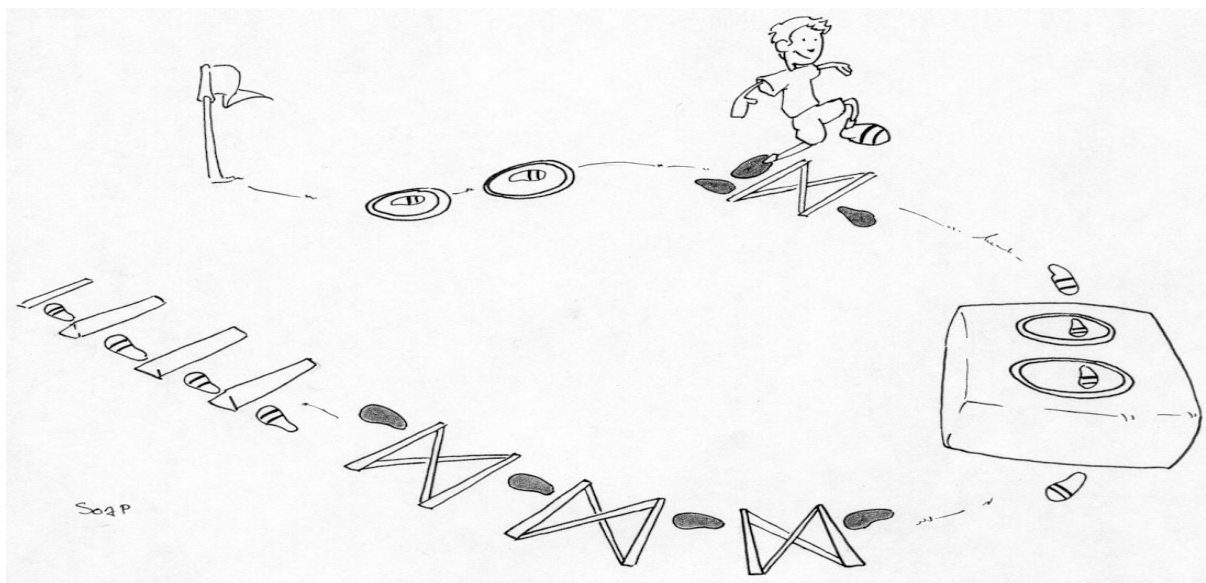

Instructions for the exercise:

- Get over ground support
- Use your arms to move ahead

Noticeable points:

- The athlete is able to bounce (so: good placement on first touchdown)
- The athlete keeps a balanced position while hopping and after the hop

Teaching progression:

- Vary the courses
- Offer various distances following an increasing scale
- Repeat several hops
- Move towards games

Safety:

- Soft ground
- Safe obstacles (course)

Equipment:

- Horizontal markers (obstacles)
- Vertical markers (for the course)

*** This training situation is valid for the limited triple jumping event.**

Educational Card 3: Triple Jump and Long Jump with short run-up

Objective: To experiment and master the hop/step sequence without loss of speed

Proposed situation: Achieve hop/step sequences within various limited spaces at various speed.

The beginner's behaviour: Beginners often carry out small hops and big steps. They often deviate from the correct jumping trajectory because they lose balance in the hopping action. They do not use or misuse the free segments (arms and legs) to move forward.

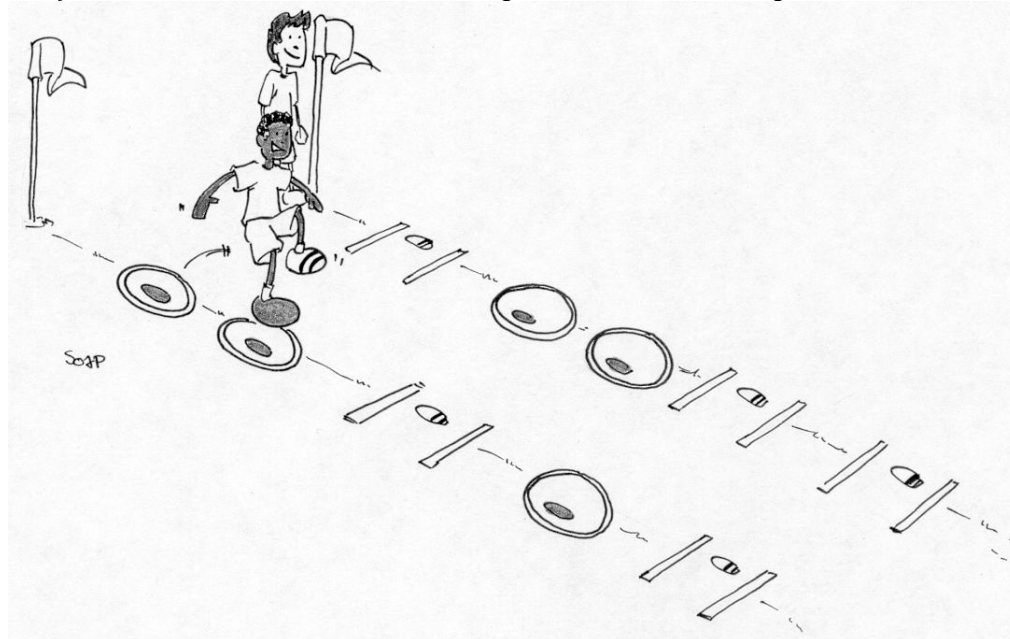

Instructions for the exercise:

- No break between hops and steps
- Do not collapse while jumping

Noticeable points:

- Complete the jumping sequence in a balanced position
- Complete the jumping sequence without loss of speed
- Appropriate use of the free segments

Teaching progression:

- Vary the jumping sequence (double hop, step and double step hop, etc.)
- Require synchronization then de-synchronization of the arms: alternatively and simultaneously)
- Vary the practicing areas and the distances between jumps
- Move towards games

Safety:

- Soft ground
- Safe equipment

Equipment:

- Horizontal markers (jumping area)
- Markers for the course

*** This training situation is valid for the limited triple jumping event.**

Educational Card 4: Triple Jump and Long Jump with short run-up

Objective: Efficient use of the arms in the jumping technique

Proposed situation: Completing hop/step sequences, try to coordinate the arms in different ways (simultaneous, synchronized, alternative with lower limbs).

The beginner's behaviour: Beginners have great difficulty coordinating the action of their arms with each support. Their arms often generate balance more than action.



Instructions for the exercise:

- Start with small bouncing areas
- Practice with relaxed arms and shoulders

Noticeable points:

- Achievement of the required programme
- Good general balance during the jumping sequences
- Similar efficiency in both arms practicing formula

Teaching progression:

- Vary the courses
- Vary the spaces
- Link alternative practicing and synchronized practicing
- Move towards games

Safety:

- Soft ground
- Appropriate jumping areas

Equipment:

- Horizontal markers
- Vertical markers

*** This training situation is valid for the limited triple jumping event.**

Educational Card 5: Triple Jump and Long Jump with short run-up

Objective: To set the measures for a short run-up

Proposed situation: From a distance marked out every 20m, the participant tries to organise a precise run-up to take-off near the take-off board.

The beginner's behaviour: Beginners have difficulty repeating similar run-ups. They are weak in adjusting their last strides to the remaining distance.



Instructions for the exercise :

- Vary the starting areas to find your own run-up distance
- Try to maintain a regular run from one trial to another

Noticeable points:

- Precise take-off
- Land on take-off foot
- Do not slow down nearing the take-off board

Teaching progression:

- Slightly modify the spaces proposed
- Place an intermediary marker at midway of the area

Safety: Equipment:

- Soft landing area Markers, crossbars
- Organised group A measuring tape
- Appropriate run-up areas

*** This training situation is valid for the limited triple jumping event.**

EDUCATIONAL CARD: HIGH JUMP

Notes: In Kids' Athletics Events, the High Jump is not presented for three main reasons:

- Competitions are too long to be included in Kids' Athletics
- To achieve a high trajectory without a secure landing can put the children's safety at risk
- The current "cultural" technique (Fosbury Flop) is too complex.

These notes do not exempt educators from anticipating the future and proposing high jump exercises to the children. On no account, the exercises should lead to any significant loss of balance. The landing should always be with both feet.

Examples of preparatory exercises to high jump:

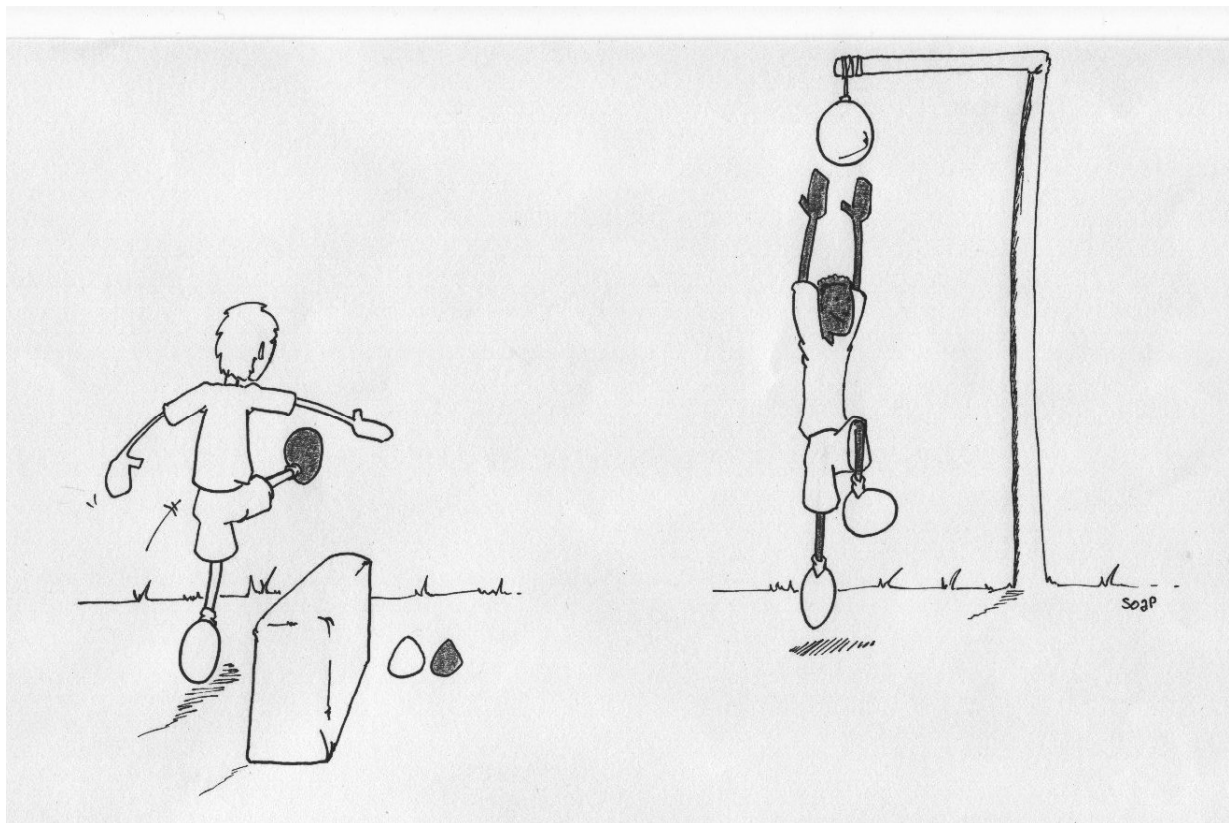

As in all other events, the body should be upright in the take-off phase, and free segments should be used efficiently.

High jumping from the left foot and the right foot could be practiced to improve general coordination.

EDUCATIONAL CARDS: RACE WALKING

This specific event in Athletics can be introduced to young children through playful activities.

Kids' Athletics Competition does not include the race walking event for technical reasons, as the race walking technique is difficult to master for very young children. However, it offers an excellent educational practice for the feet, for coordination, for the aerobic system for children with difficulties.

For the above reasons, Race Walking completes the other events and need to be introduced to children during practical sessions.

1- Basic characteristics

Following the race walking technical rules, the walker has to:

- maintain ground contact at all times
- straighten the support leg in the vertical upright position



2- Practice of Race Walking

Elementary exercises are proposed to the children so that they experiment the basis of race walking. It is recommended first to emphasize the quality of the walking technique rather than the walking speed.

You are invited to adapt all the existing exercises for long distance running, adjusting the pace and the distance to the race walking event. It would also be very instructive to organise "walking sequences" combined with "running sequences"; and attractive for children to make them complete all possible forms of relays as race walking.

In Race Walking, most of the exercises for Relays can be exploited, the only condition being to remove the obstacles/hurdles from the courses.

Educational Card 1: Race Walking

Objective: To experiment race walking

Proposed situation: Make the children complete various slalom courses in Race Walking strides.

The beginner's behaviour: Beginners tend to bend their trunk forward, not to use the action of their arms, or the full rolling movement along their foot. Their knees can be bent.

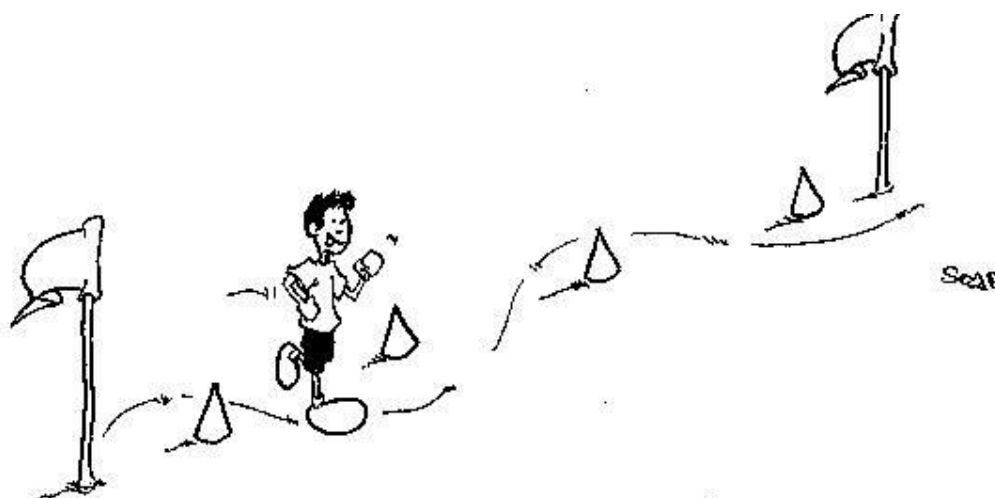

Instructions for the exercise:

- Keep the body in a straight upright position
- Use the arms actively
- Eyes look ahead

Noticeable behaviour:

- Legs are straightened in the vertical support position
- Arm movements are wide and in the direction of the race
- Head on the same level, eyes look ahead horizontally

Teaching progression:

- Vary the courses
- Keep the time for each course
- Run back and forth relays

Safety:

- Organise the group
- Safe ground

Equipment:

- Vertical markers
- A stopwatch

Educational Card 2: Race Walking

Objective: To discover the foot placement in race walking

Proposed situation: In race walking strides children have to complete a distance marked out with crossbars at various intervals. It is possible to increase the intervals progressively.

The beginner's behaviour: Beginners tend to bend their trunk forward, not to use the action of their arms, or the full rolling movement along their foot. They may bend their knees as the distances increase.

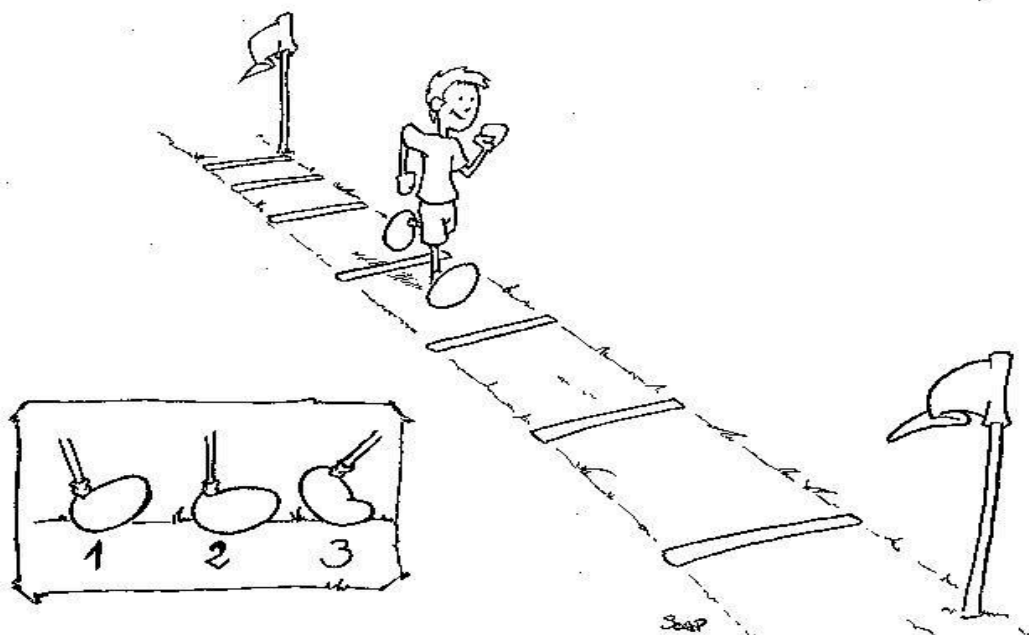

Instructions for the exercise:

- Maintain the body straight in upright position
- Touchdown is on the heel and is followed by a rolling movement along the foot
- Legs are straightened in vertical support position
- Arm movements are wide and in the direction of the race
- Head on the same level, eyes look ahead horizontally

Teaching progression:

- Vary the courses
- Keep the time for each course
- Run relays, one way with increasing stride length, the other with slaloming

Safety:

- Organise the group
- Safe ground

Equipment:

- Vertical and horizontal markers
- A stopwatch

Educational Card 3: Race Walking

Objective: To adjust one's pace (stride length and rhythm) to another participant's

Proposed situation: In race walking strides children have to complete various distances, working in "twos", both participants being linked with sticks or javelins.

The beginner's behaviour: Beginners have difficulty walking together and adjusting to the other's specific pace.

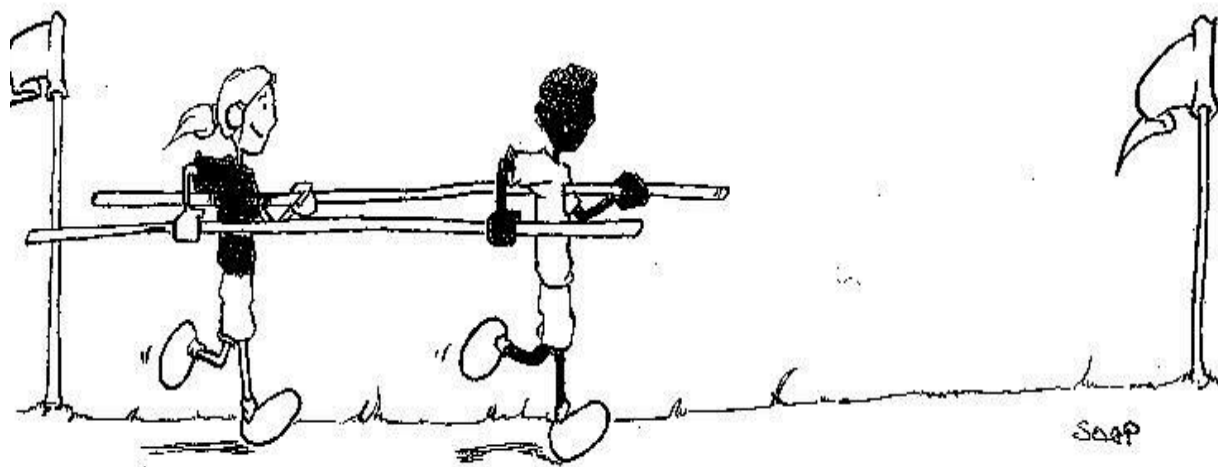

Instructions for the exercise:

- Perfect coordination between partners
- Maintain the body straight in vertical position
- Touchdown is on the heel and is followed by a rolling movement along the foot
- The eyes look ahead

Noticeable behaviour:

- Remain relaxed to be driven by the leader's action

Teaching progression:

- Vary the courses
- Take turns
- Run relays

Safety:

- Organise the group
- Safe ground
- Work in balanced "twos" (height)

Equipment:

- Vertical and horizontal markers
- A stopwatch
- Sticks, bamboo, etc.

Educational Card 4: Race Walking

Objective: To separate the arm movement from the walking technique

Proposed situation: Make the children carry out various distances with walking strides in teams of 2 participants. Using balls, walkers will make lateral passes with both hands.

The beginner's behaviour: Beginners have difficulty working together. Passing and catching the ball are not controlled.

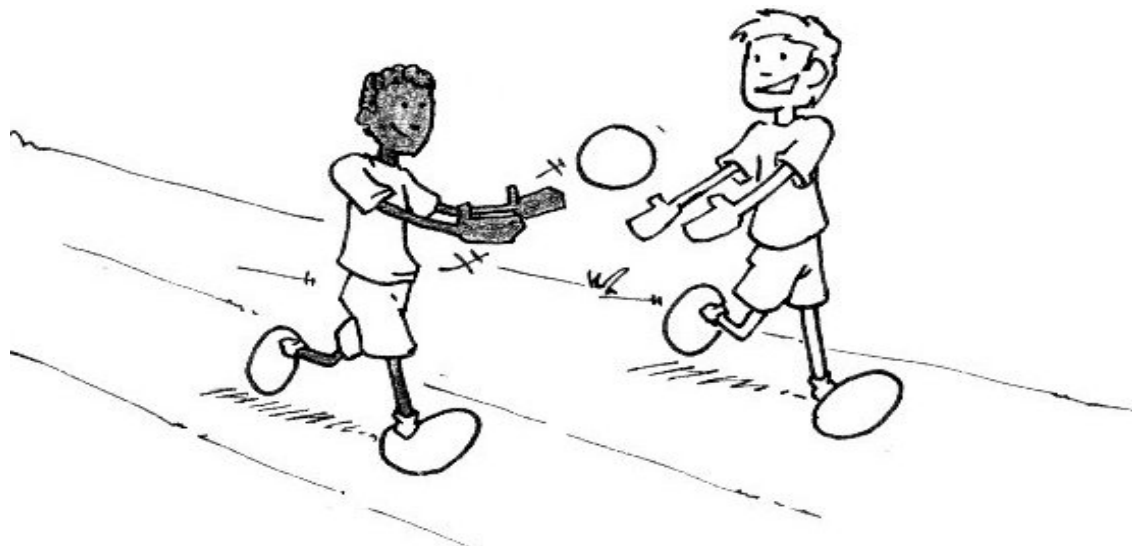

Instructions for the exercise:

- Perfect coordination between partners
- Maintain the body straight in vertical position
- Isolate throws/passes from the walking technique

Noticeable points:

- Remain relaxed to separate arms/legs
- Maintain a regular walking stride from a technical and directional point of view

Teaching progression:

- Vary the throwing distances, the throwing sides
- Vary the throwing implements (bigger, smaller, etc.)
- Run relays

Safety:

- Organise the group
- Safe ground
- Appropriate and safe throwing implements

Equipment:

- Vertical markers
- A stopwatch
- Balls, hoops, etc.

Educational Card 5: Race Walking

Objective: To be able to achieve a speed stride rhythm

Proposed situation: Over distances marked out with short spaces, the participants walk with 1,5 stride or 2 in the spaces. The exercise requires correcting the foot placement and increasing the speed.

The beginner's behaviour: Beginners have difficulty performing a regular rolling movement along the foot as the speed increases.

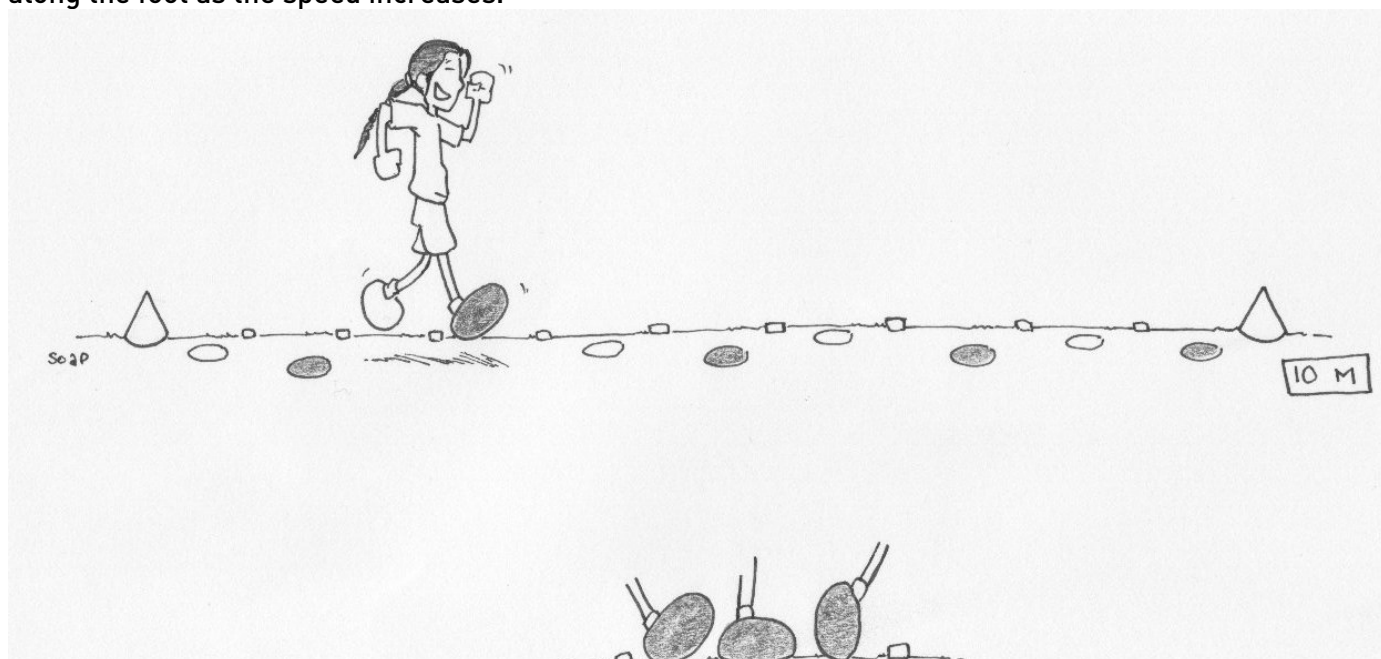

Instructions for the exercise:

- Manage one footstep in each space (or two depending on the organisation of the course: 3, 4 footsteps / space)
- Maintain the body straight in vertical position
- Widen the rolling movement along the foot

Noticeable points:

- Remain relaxed to gain speed
- Maintain a regular technique of race walking

Teaching progression:

- Vary the walking practice from 5m to 15m
- Complete the exercise with hands above the head
- Carry out relays

Safety:

- Organise the group
- Safe ground
- Flat markers

Equipment:

- Vertical markers
- A stopwatch
- Flat and soft crossbars