

Velocity and stride parameters in the 400 Metres

 © by IAAF
22:3; 39-46, 2007

By Bruno Gajer, Christine Hanon, Chantalle Thepaut-Mathieu

Success in the 400m requires the athlete to preserve the optimal technical characteristics of his/her stride despite intense fatigue. Using 50m intervals, the time courses of velocity and stride parameters (length and frequency) were evaluated for races of three groups of athletes: world-class, national level and regional level. The better athletes were able to achieve higher absolute and relative velocities (% of their best performance over 200m). These were reached by way of both significantly greater stride length and stride frequency. It is notable that peak values for the two parameters were observed in different parts of the race: between 50 and 100m for stride frequency and between 100 and 150m for stride length. In general, length rather than frequency is the stride parameter distinguishing the groups from each other. As the morphological characteristics of the subjects were similar, this could indicate greater maximal strength levels for the better athletes.

ABSTRACT

Bruno Gajer is one of the coaches of the French Athletics Federation. His athletes are training at INSEP, the French Olympic Campus and are 400 or middle-distance national or international runners. Four of them were selected for the Osaka world championships.

Christine Hanon, PhD, is the director of the Biomechanics and Physiology Laboratory at INSEP. As an athlete, she represented France in the 800m.

Chantalle Mathieu, PhD, is the head of INSEP Sport Sciences department.

AUTHORS

order to be successful. For this reason, the event has been of interest for researchers in both physiology (NUMMELA et al., 1992; HIRVONEN & NUMMELA, 1992; HEUGAS et al., 1997; DUFFIELD et al., 2005) and biomechanics (NUMMELA et al. 1992; BATES & HAVEN, 1974; SPRAGUE & MANN, 1983).

Some analyses, notably those from IAAF projects at the World Championships in Athletics, have focused on the time course of the velocity throughout the race with a preciseness of 50m (BRÜGGEMANN et al., 1999) however the available biomechanical data mainly compares the start and the end of the race (BATES & HAVEN, 1974) or is on the basis of 100m divisions (BELLOC, 1992; NUMMELA et al., 1992).

Introduction

The 400 metres is one of the most demanding athletics disciplines, in which the athlete must be able to preserve the optimal technical characteristics of his/her stride despite intense fatigue in

Table 1: Performances of the different groups (average + SD)

	World-Class	National	Regional
Men	44.43 + 0.16 (n=5)	46.83 + 0.52 (n=5)	48.24 + 0.31 (n=5)
Women	49.97 + 0.33 (n=5)	53.06 + 0.50 (n=5)	55.33 + 0.30 (n=5)

The aim of the present study was to evaluate both the time course of the velocity and the stride parameters (length and frequency) for 50m segments of 400m races at three different levels of performance.

Methodology

Population

Six groups of five athletes each were selected. The groups included three levels of performance for both sexes: world-class, national and regional. Each group was homogeneous and the 6 groups were statistically different. The average and range of the performances studied for the athletes in each group are given in Table 1.

Protocol

The study was based on video data but was carried out according to two different methods: one for the world-class groups and the other for the national and regional groups.

The analysis of the two world-class groups used the video material produced by the IAAF's Biomechanics Research Project at the 1997 World Championships in Athletics. This study provided the velocities over 50m segments for each athlete (BRÜGGEMANN et al., 1999).

To find the stride length for our study, the number of strides was visually determined from the video document. It was necessary to exactly evaluate the part of the stride before and after the markers separating the eight 50m segments. This was done by taking the time at n (foot-contact before the line) and the time at $n+1$ (foot-contact after the line) and then calculating a percentage (see Figure 1). The mean stride frequency was calculated from

the stride length and the velocities as follows: Stride frequency = velocity/stride length.

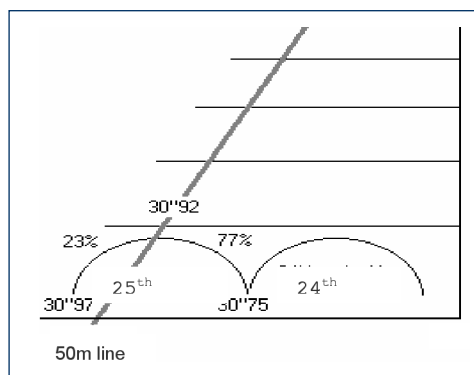

Figure 1: Method for calculating the percentage of a stride crossing the markers separating 50m segments

The analysis of national and regional groups used video material specifically collected for the study. Before the competitions, the track was marked every 50m in each lane. On both sides of the 50m line, additional marks were placed every 20cm to 140cm (Figure 2). The recording system consisted of 16 videotape recorders (Panasonic Super-VHS) with a double framework that allows recording at 50 frames per second and thus decreases the error of measurement to 0.01 sec for each 50m. The positions of the recorders are shown in Figure 3. As can be seen, three recorders were placed in the stands to get panoramic views with the aim of counting the stride number in each 50m section. These cameras focused on lanes 1 to 3, 4 to 8, and 1 to 8 (additional camera), respectively. Thirteen synchronised cameras gave the times for each 50m segment. When no gap existed between the lanes, only one camera was necessary. When there was a significant gap, two or three cameras were provided.

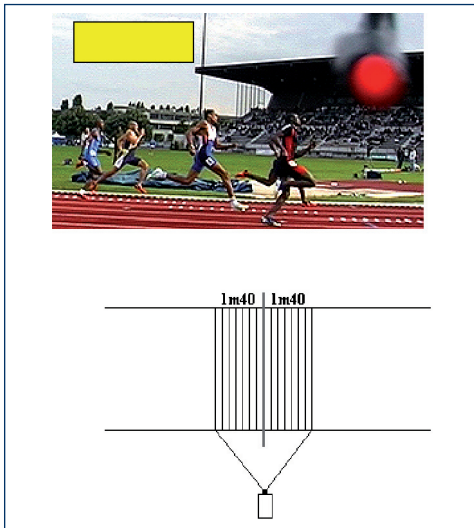

Figure 2: Camera view and marking system

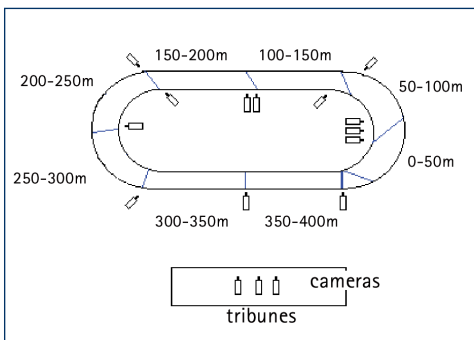

Figure 3: Camera positions in the stadium

The average stride length (distance/number of strides) was calculated for each 50-m section (margin of error: 2.5cm). The exact stride lengths were calculated with the help of the additional marks on both sides of the lines.

The average velocity for each segment was calculated from times recorded for the 50m segments.

Results

Velocity

The time courses of velocity of each group by 50m segments are shown graphically in Figures 4a and 4b.

As can be seen in the figures, all the athletes, regardless of performance level, reached their peak velocity between 50m and 100m. As might be expected, the velocities of the world-class groups are, for the most part, significantly greater than the other levels from the start of the race. However, the final decrease in velocity was greatest for the world-class athletes, particularly in the female group.

Three distinct phases of the race can be identified:

- An acceleration phase from the start and until the end of the first bend
- A progressive decrease in velocity (until the 300-m or 400-m mark)
- An important decrease in velocity (last 100m)

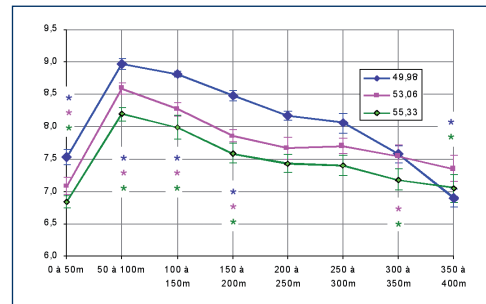

Figure 4a: Time course of velocity (women)

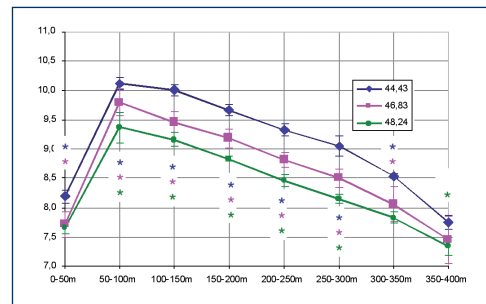

Figure 4b: Time course of velocity (men)

*, **, *: the differences are significant between M and N, M and R, N and R respectively

Stride length

The time courses of the stride lengths of each group are shown graphically in Figures 5a and

5b. The stride lengths given are the average for the strides of the respective 50m segments.

given are the average for the respective 50m segments.

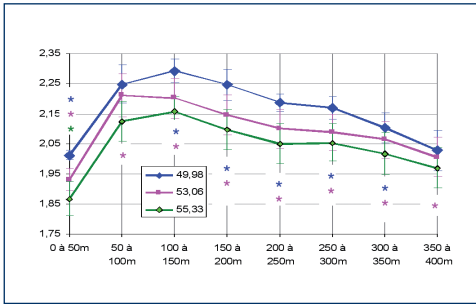

Figure 5a: Time course of stride length (women)

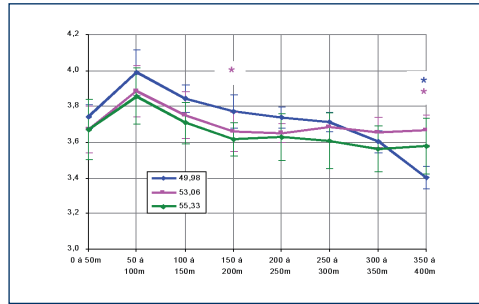

Figure 6a: Time course of stride frequency (women)

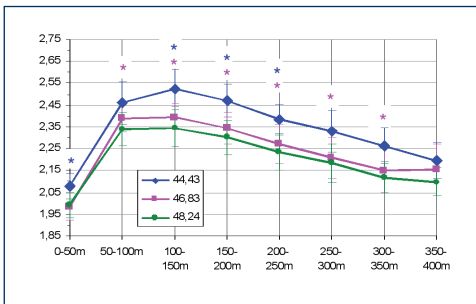

Figure 5b: Time course of stride length (men)

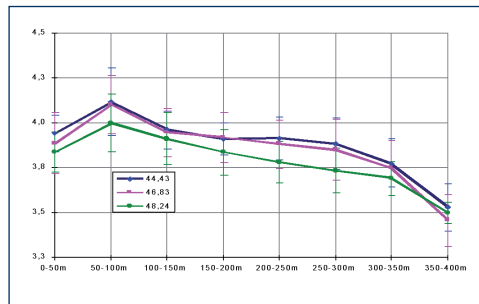

Figure 6b: Time course of stride frequency (men)

*, *, * : the differences are significant between M and N, M and R, N and R respectively

*, *, * : the differences are significant between M and N, M and R, N and R respectively

Except at the end of the race, the stride length values of the world-class runners were significantly greater than those of the other levels.

In all the groups, the maximum stride frequency was reached in the 50 to 100m segment of the race, when velocity was at its maximum. For the women, the peak values were 3.99 ± 0.13 Hz, 3.89 ± 0.14 Hz and 3.86 ± 0.16 Hz respectively for the world-class, national and regional groups. The final decrease in stride frequency was particularly great from 250 to 400m in world-class group and contrary to the national and regional groups. Except for the two last 50m segments the differences between the groups were not significant.

The peak stride length values were 2.29 ± 0.04 m, 2.21 ± 0.07 m and 2.16 ± 0.05 m respectively for the world-class, national and regional level female runners and 2.53 ± 0.08 m, 2.40 ± 0.06 m and 2.35 ± 0.08 m respectively for the three groups of male runners. The peak values were observed in the 100 to 150m segment of the race, except for the national level runners who reached their peak values earlier.

The peak values for the three male groups were 4.12 ± 0.19 , 4.41 ± 0.16 and 4.00 ± 0.16 Hz, respectively. The differences between the frequency values were not significantly different between the groups. The decrease in stride frequency in the last 100m was similar for the three levels.

Stride frequency

The time courses of the stride frequencies of each group are shown graphically in Figures 6a and 6b. The stride frequencies

Table 2: Velocity and stride parameter variation in the first 100m (WR= world-class, NR=national level, RR=regional level)

	Women			Men		
	WR	NR	RR	WR	NR	RR
Velocity	+19%	+21.3%	+19.7%	+23.6%	+27.1%	+22.5%
Length	+12%	+14.5%	+13.9%	+18.3%	+20.1%	+17%
Frequency	+6.7%	+6%	+5.2%	+4.6%	+5.4%	+4.2%

Table 3: Velocity and stride parameter variation in the second 100m (WR= world-class, NR=national level, RR=regional level)

	Women			Men		
	WR	NR	RR	WR	NR	RR
Velocity	-5.47%	-8.61%	-7.32%	-4.54%	-6.3%	-5.8%
Length	0%	-2.71%	-5.91%	+0.4%	-1.7%	-1.7%
Frequency	-5.51%	-5.91%	-6.22%	-5.1%	-4.4%	-4%

Table 4: Velocity and stride parameter variation in the third 100m (WR= world-class, NR= national level, RR= regional level)

	Women			Men		
	WR	NR	RR	WR	NR	RR
Velocity	-4.96%	-1.91%	-2.5%	-6.3%	-7.4%	-7.7%
Length	-3.55%	-2.79%	-2.38%	-5.7%	-6%	-4.8%
Frequency	-1.59%	+0.54%	-0.27%	-0.8%	-1.78%	-2.9%

Relative importance of stride length and frequency to variations in velocity

Table 2 shows the changes in velocity, stride length and stride frequency in the first 100m of the race for all three groups. Although both stride length and stride frequency increase, and thus contribute to the increase in velocity in this part of the race, stride length (highlighted in red) appears to be the more important factor.

Table 3 shows the changes in velocity, stride length and stride frequency in the first

100m of the race for all three groups. Here the decrease in stride frequency (highlighted in red) appears to be the most important factor contributing to the loss of velocity. It must be noted that the stride length of both world-class groups remained constant.

Table 4 shows the changes in velocity, stride length and stride frequency in the first 100m of the race for all three groups. In this section of the race the decrease in stride length (highlighted in red) appears to be the most important factor contributing to the loss of velocity.

Table 5: Velocity and stride parameter variation from 300 to 350m (WR= world-class, NR=national level, RR=regional level)

	Women			Men		
	WR	NR	RR	WR	NR	RR
Velocity	-5.84%	-2.2%	-2.97%	-5.75%	-5.2%	-3.9%
Length	-3.22%	-1.43%	-1.46%	-3%	-2.7%	-3.2%
Frequency	-2.96%	-0.81%	-1.38%	-2.8%	-2.6%	-1.1%

Table 6: Velocity and stride parameter variation from 350 to 400m (WR= world-class, NR=national level, RR=regional level)

	Women			Men		
	WR	NR	RR	WR	NR	RR
Velocity	-8.97%	-2.39%	-1.81%	-9.1%	-7.6%	-6.1%
Length	-3.33%	-2.43%	-2.47%	-2.6%	+0.4%	-0.9%
Frequency	-5.55%	+0.55%	+0.56%	-6.4%	-7.8%	-5.1%

Table 5 shows the changes in velocity, stride length and stride frequency between 300 and 350m for all three groups. In this section, the loss of velocity was the result of a combination of decreases in stride length and stride frequency.

Table 6 shows the changes in velocity, stride length and stride frequency between 350 and 400m for all three groups. Here, the decrease in velocity was mostly due to the decrease in stride frequency for the men and the best women.

Discussion

Peak velocity

The peaks of velocity (10.12m/s⁻¹ for world-class men and 8.96m/s⁻¹ for world-class women) are about 10% greater than the velocities analysed by 100m segments (BRÜGGEMANN, 1999; BELLOC, 1992) for the same level of performance. The peaks of velocity in the world-class, national and regional groups are significantly different ($p < 0.05$) from what could be attributed to the

maximal velocity of each runner and/or to the pacing strategy adopted. Based on Table 7, the world-class runners had a better 200m best performance and they used the greater part of their maximal velocity (96–97% for the best performance). This could indicate greater risk-taking and obviously greater physiological capacities allowing that risk-taking.

It was observed that velocity increase was obtained by an increase in both stride length and frequency, as previously described in an analysis of the 100 metres (GAJER et al., 1999). During the 400m, the maximal stride frequency was reached during the second part of the first bend, when the peak of velocity was reached. However, the peak of the stride length was achieved later, at the beginning of the first straight line (see Figure 7). One can hypothesize that these differences compared to the 100m race are due to the presence of the bends: the centre of mass must move tangent to the curve of the track, which implies centripetal push-offs and a mechanical constraint added to the horizontal and vertical push-off phases of the stride.

Table 7: Comparison of personal best performances over 200m and the time at 200m during the 400m (The average 200m best performances of the runners in each group is shown in red; the second column shows the time at 200m during the 400m. The differences are expressed in seconds and in % of the best performance. WR= world class, NR=national level, RR=regional level.)

	Men				Women			
	200	200	difference	%200	200	200	difference	%200
WR	20.72 ± 0.05	21.22 ± 0.08	0.51 ± 0.11	97.62 ± 0.51	22.98 ± 0.29	23.80 ± 0.18	0.87 ± 0.18	96.34 ± 0.75
NR	21.09 ± 0.24	22.33 ± 0.42	1.24 ± 0.29	94.44 ± 1.21	24.29 ± 0.65	25.31 ± 0.17	1.09 ± 0.68	95.72 ± 2.66
RR	21.59 ± 0.32	23.00 ± 0.25	1.41 ± 0.52	93.89 ± 2.18	24.63 ± 0.27	26.26 ± 0.25	1.64 ± 0.19	93.77 ± 0.73

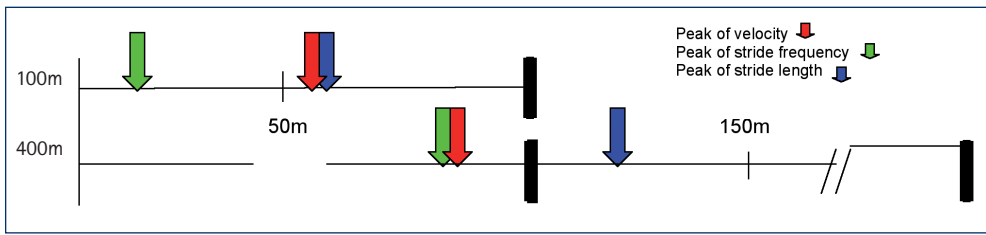

Figure 7: Chronology of appearance of the peaks of velocity, stride length and stride frequency in the 100m (GAJER et al., 1999) and the 400m races

Velocity decrease

The decrease in the velocity observed was greater (more than 20% between the peak and the final velocities) than previously described in studies analysed by 100m segments (14 to 19%) (BRÜGGEMANN, 1999; BELLOC, 1992).

It is interesting to note that the decrease in the velocity recorded in the last 50m and in the last 100m was greater for the world-class runners than for the other levels of performance (Tables 5 and 6). That could indicate whether a greater mental commitment or a greater capacity to run in fatigue conditions.

In the last 50m, both stride frequency and length decreased in all groups. The decrease in the stride frequency was greater than the decrease in the stride length and did not differ between levels of performance.

It is notable that the difference between the peak and the final stride length was significantly greater for the world-class runners than for the other groups (Figure 5a and 5b).

Over the course of the races, the stride frequency was not the discriminating parameter differentiating the levels of expertise. Except for the last 100m for the female groups, no significant difference between the groups was observed. On the contrary, the stride length was significantly greater for the world-class groups resulting in significantly lower stride numbers (185, 193, 198 respectively for the female world-class, national and regional groups and 172, 179, 182 respectively for the male groups). As the morphological characteristics of the subjects were similar (Table 8), the results could indicate greater maximal strength levels for the better athletes.

Table 8: Average (+ SD) of morphological characteristics of the subjects (WR= world-class, NR=national level, RR=regional level)

	Men		Women	
	Height	Maximum stride length	Height	Maximum stride length
WR	1.84 m ± 0.06	2.53 m	1.70 m ± 0.04	2.29 m
NR	1.85 m ± 0.05	2.40 m	1.70 m ± 0.05	2.21 m
RR	1.81 m ± 0.05	2.35 m	1.67 m ± 0.05	2.16 m

Conclusion

This study showed that it is interesting to carry out an in-depth investigation of the speed and stride parameters in the 400 metres. The results obtained by studying 50m segments are different from those obtained using 100m segments. The time/distance corresponding to the peaks of velocity, stride length and stride frequency are modified by this method. In the same way, it was possible to make a more in-depth analysis of the appearance and consequence of fatigue in the second half of the race.

This study has shown that the best athletes are able to reach higher absolute and relative velocities (% of their 200-m best performance). These higher velocities are obtained by the way of significantly greater stride length

(2.53m and 2.29m for the best men and women, respectively) and stride frequency (4.12Hz and 3.99Hz for the best men and women). It is notable that these peak values were observed at different distances: between 50 and 100m for the peak frequency and between 100 and 150m for the peak length and one can hypothesize that this difference is due to the presence of bends. Finally, a greater loss of velocity in the second half of the race was observed in the best athletes as compared to the other levels of performance, due mainly to a greater decrease in stride length.

Please send all correspondence to:

Christine Hanon
christine.hanon@insep.fr

REFERENCES

- BATES, B. & HAVEN, B. (1974). Effect of fatigue on the mechanical characteristics of highly skilled female runners. In: *Biomechanics IV*, RC Nelson and Morehouse (eds) Baltimore: University Park Press, pp 121-125.
- BELLOC, O. (1992). 400m Haies: les enseignements du 400m plat. Publications INSEP collection entraînement, pp 83.
- BRÜGGEMANN, G.-P.; KOSZEWSKI, D. & MÜLLER, H. (1999). *Report of the IAAF Biomechanics Research Project Athens 1997*. Monaco: International Athletic Foundation, Meyer & Meyer Sport 2.1:54-62.
- DUFFIELD, R.; DAWSON, B. & GOODMAN, C. (2005). Energy system contribution to 400-meter and 800-meter track running. *Journal of Sport Science*, 23 (3): 299-307.
- NUMMELA, A.; VURORIMAA, T. & RUSKO, H. (1992). Changes in force production, blood lactate and EMG activity in the 400m sprint. *Journal of Sport Science*, 107:217-228.
- HIRVONEN, J. & NUMMELA, A. (1992). Fatigue and changes of ATP, creatine phosphate and Lactate during 400-m sprint. *Canadian Journal of Sport Science*, 17:141-144.
- HEUGAS, A.M.; BRISSWALTER, J. & VALLIER, J.M. (1997). Effect of a three month training period on the maximal oxygen deficiency in high level performance sprinters. *Canadian Journal of Applied Physiology*, 22: 171-181.
- SPRAGUE, P. & MANN, R. (1983). The effects of muscular fatigue on the kinetics of sprint running. *Res Quarterly of Exercise and Sport*, 54:60-66.